

KENWOOD

MINIDISC RECORDER

DM-SE7

INSTRUCTION MANUAL

KENWOOD CORPORATION



B60-3319-00 (JA) (K, T, M) AP

98/12 11 10 9 8 7 6 5 4 3 2 1 97/12 11 10 9 8 7

Before applying power **Caution : Read this section carefully to ensure safe operation.**

Units are designed for operation as follows.

U.S.A. and Canada **AC 120 V only**
 Europe and U.K. **AC 230 V only**
 Taiwan **AC 110 V only**

For the United Kingdom

Factory fitted moulded mains plug

1. The mains plug contains a fuse. For replacement, use only a 13- Amp ASTA-approved (BS1362) fuse.
2. The fuse cover must be refitted when replacing the fuse in the moulded plug.
3. Do not cut off the mains plug from this equipment. If the plug fitted is not suitable for the power points in your home or the cable is too short to reach a power point, then obtain an appropriate safety approved extension lead or adapter, or consult your dealer. If nonetheless the mains plug is cut off, remove the fuse and dispose of the plug immediately, to avoid a possible shock hazard by inadvertent connection to the mains supply.

IMPORTANT :





The wires in the mains lead are coloured in accordance with the following code :

- Blue : Neutral
- Brown : Live

Do not connect those leads to the earth terminal of a three - pin plug.

Safety precautions **Caution : Read this section carefully to ensure safe operation.**

WARNING : TO PREVENT FIRE OR ELECTRIC SHOCK, DO NOT EXPOSE THIS APPLIANCE TO RAIN OR MOISTURE.

 <div style="border: 1px solid black; padding: 5px; display: inline-block;"> <p style="text-align: center; margin: 0;">CAUTION</p> <p style="text-align: center; margin: 0; font-size: small;">RISK OF ELECTRIC SHOCK DO NOT OPEN</p> </div> 	<p>CAUTION: TO REDUCE THE RISK OF ELECTRIC SHOCK, DO NOT REMOVE COVER (OR BACK). NO USER-SERVICEABLE PARTS INSIDE, REFER SERVICING TO QUALIFIED SERVICE PERSONNEL.</p>
	<p>THE LIGHTNING FLASH WITH ARROWHEAD SYMBOL, WITHIN AN EQUILATERAL TRIANGLE, IS INTENDED TO ALERT THE USER TO THE PRESENCE OF UNINSULATED "DANGEROUS VOLTAGE" WITHIN THE PRODUCT'S ENCLOSURE THAT MAY BE OF SUFFICIENT MAGNITUDE TO CONSTITUTE A RISK OF ELECTRIC SHOCK TO PERSONS.</p>
	<p>THE EXCLAMATION POINT WITHIN AN EQUILATERAL TRIANGLE IS INTENDED TO ALERT THE USER TO THE PRESENCE OF IMPORTANT OPERATING AND MAINTENANCE (SERVICING) INSTRUCTIONS IN THE LITERATURE ACCOMPANYING THE APPLIANCE.</p>

The marking of products using lasers (Except for some areas)



The marking is located on the rear panel and says that the component uses laser beams that have been classified as Class 1. It means that the unit is utilizing laser beams that are of a weaker class. There is no danger of hazardous radiation outside the unit.

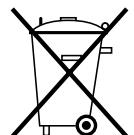

REQUIREMENT BY NEDERLAND GAZETTE

Batteries are supplied with this product. When they empty, you should not throw away. Instead, hand them in as small chemical waste.



Contents

Caution : Read the pages marked  carefully to ensure safe operation.

Introduction	2
 Before applying power	2
 Safety precautions	2
 IMPORTANT SAFEGUARDS	4
Before operation	6
Accessories	6
Special feature	7
Safety Precautions	8
Maintenance	9
MD system	10
System connections	12
System operation features	13
Names and functions of parts	14
Display/Main unit	14
Remote control unit	15
Operation of remote control unit	16
Playback of Mini Disc	17
Playing tracks in order from track No. 1	17
Playback from desired track	18
Listening in random order (RANDOM playback)	18
Searching a desired track by its title (TITLE SEARCH)	20
Programming	21
Programming tracks in a desired order	21
Repeated playback	23
Recording (analog input)	24
Analog recording	24
Recording (digital input)	26
Digital recording	26
Digital recording and SCMS	28
Simplified CD recording	29
Recording a single CD track (O.T.E.)	29
Recording all tracks on a CD (O.T.E.)	29
Synchro recording with CD player	29
Changing the displayed contents	30
TIME DISPLAY key	30
TEXT DISPLAY key	30
Editing	31
Selecting the editing function type	31
Changing tracks during playback (TRACK MOVE)	32
Moving several tracks at a time (QUICK MOVE)	34
Dividing a track during playback (TRACK DIVIDE)	36
Combining tracks during playback (TRACK COMBINE)	38
Erasing several tracks at a time (QUICK ERASE)	40
Erasing a single track during playback (TRACK ERASE)	42
Erasing a part of a track	43
How to edit titles	44
Changing or deleting a title	46
CD Text Editing	48
In case of difficulty	49
Specifications	52

IMPORTANT SAFEGUARDS

⚠ Caution : *Read this section carefully to ensure safe operation.*

Please read all of the safety and operating instructions before operating this appliance. Adhere to all warnings on the appliance and in the instruction manual. Follow all the safety and operating instructions. These safety and operating instructions should be retained for future reference.

- 1. Power sources** – The appliance should be connected to a power supply only of the type described in the instruction manual or as marked on the appliance. If you are not sure of the type of power supply to your home, consult your appliance dealer or local power company. For appliances intended to operate from battery power, or other sources, refer to the instruction manual.
- 2. Power-cord protection** – Power-supply cords should be routed so that they are not likely to be walked on or pinched by items placed upon or against them, paying particular attention to cords at plugs, convenience receptacles, and the point where they exit from the appliance.
- 3. CAUTION – Polarization** – This appliance may be equipped with a polarized alternating-current line plug (a plug having one blade wider than the other). This plug will fit into the power outlet only one way. This is a safety feature. If you are unable to insert the plug fully into the outlet, try reversing the plug. If the plug should still fail to fit, contact your electrician to replace your obsolete outlet. Do not defeat the safety purpose of the polarized plug.
- 4. Ventilation** – Slots and openings in the cabinet are provided for ventilation and to ensure reliable operation of the appliance and to protect it from overheating, and these openings must not be blocked or covered. The appliance should be situated so that its location or position does not interfere with its proper ventilation.
To maintain good ventilation, do not put records or a table-cloth on the appliance. Place the appliance at least 10 cm away from the walls.
Do not use the appliance on a bed, sofa, rug or similar surface that may block the ventilation openings. This appliance should not be placed in a built-in installation such as a bookcase or rack unless proper ventilation is provided or the manufacturer's instructions have been adhered to.
- 5. Water and moisture** – The appliance should not be used near water - for example, near a bathtub, washbowl, kitchen sink, laundry tub, in a wet basement, or near a swimming pool, etc.
- 6. Temperature** – The appliance may not function properly if used at extremely low, or freezing temperatures. The ideal ambient temperature is above +5°C (41°F).
- 7. Heat** – The appliance should be situated away from heat sources such as radiators, heat registers, stoves, or other appliances (including amplifiers) that produce heat.
- 8. Electric shock** – Care should be taken so that objects do not fall and liquid is not spilled into the enclosure through openings. If a metal object, such as a hair pin or a needle, comes into contact with the inside of this appliance, a dangerous electric shock may result. For families with children, never permit children to put anything, especially metal, inside this appliance.
- 9. Enclosure removal** – Never remove the enclosure. If the internal parts are touched accidentally, a serious electric shock might
- 10. Magnetic fields** – Keep the appliance away from sources of magnetic fields such as TV sets, speaker systems, radios, motorized toys or magnetized objects.
- 11. Cleaning** – Unplug this appliance from the wall outlet before cleaning. Do not use volatile solvents such as alcohol, paint thinner, gasoline, or benzene, etc. to clean the cabinet. Use a clean dry cloth.

- 12. Accessories** – Do not place this appliance on an unstable cart, stand, tripod, bracket, or table. The appliance may fall, causing serious injury to a child or adult, and serious damage to the appliance. Use only with a cart, stand, tripod, bracket, or table recommended by the manufacturer, or sold with the appliance. Any mounting of the appliance should follow the manufacturer's instructions, and should use a mounting accessory recommended by the manufacturer. An appliance and cart combination should be moved with care. Quick stops, excessive force, and uneven surfaces may cause the appliance and cart combination to overturn.
- 13. Lightning** – For added protection for this appliance during a lightning storm, or when it is left unattended and unused for long periods of time, unplug it from the wall outlet and disconnect the antenna or cable system. This will prevent damage to the appliance due to lightning and power-line surges.
- 14. Abnormal smell** – If an abnormal smell or smoke is detected, immediately turn the power OFF and unplug the appliance from the wall outlet. Contact your dealer or nearest service center.
- 15. Damage requiring service** – The appliance should be serviced by qualified service personnel when:
- The power-supply cord or the plug has been damaged.
 - Objects have fallen, or liquid has been spilled into the appliance.
 - The appliance has been exposed to rain or water.
 - The appliance does not appear to operate normally by following the instruction manual. Adjust only those controls that are covered by the instruction manual as an improper adjustment of other controls may result in damage and will often require extensive work by a qualified technician to restore the appliance to its normal operation.
 - The appliance has been dropped, or the enclosure damaged.
 - The appliance exhibits a marked change in performance.
- 16. Servicing** – The user should not attempt to service the appliance beyond that described in the instruction manual. All other servicing should be referred to qualified service personnel.
- 17. Power lines** – An outside antenna system should not be located in the vicinity of overhead power lines or other electric light or power circuits, or where it can fall into such power lines or circuits. When installing an outside antenna system, extreme care should be taken to keep from touching such power lines or circuits as contact with them might be fatal.
- 18. AC outlets** – Do not connect other audio equipment with a power consumption larger than that specified to the AC outlet on the rear panel. Never connect other electrical appliances, such as an iron or toaster, to it to prevent fire or electric shock.
- 19. Overloading** – Do not overload wall outlets, extension cords, or integral convenience receptacles as this can result in a risk of fire or electric shock.
- 20. Attachment** – Do not use attachments not recommended by the appliance manufacturer as they may cause hazards.
- 21. Replacement parts** – When replacement parts are required, be sure the service technician has used replacement parts specified by the manufacturer or have the same characteristics as the original parts. Unauthorized substitutions may result in fire, electric shock, or other hazards.
- 22. Safety check** – Upon completion of any service or repairs to this appliance, ask the service technician to perform safety checks to determine that the appliance is in proper operating condition.

Unpacking

Unpack the unit carefully and make sure that all accessories are put aside so they will not be lost. Examine the unit for any possibility of shipping damage. If your unit is damaged or fails to operate, notify your dealer immediately. If your unit was shipped to you directly, notify the shipping company without delay. Only the consignee (the person or company receiving the unit) can file a claim against the carrier for shipping damage. We recommend that you retain the original carton and packing materials for use should you transport or ship the unit in the future.

Keep this manual handy for future reference.

Accessories

Check that the following accessories are present.

Audio cord (2)

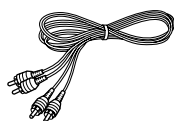

System control cord (1)

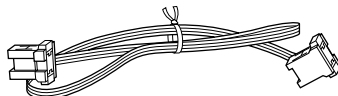

Optical fiber cable (1)

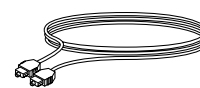

Remote control unit (1)

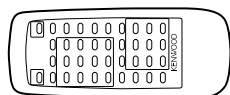

Batteries (2)

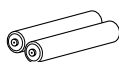

For the U.S.A.

CAUTION :

Use of controls or adjustments or performance of procedures other than those specified herein may result in hazardous radiation exposure.

In compliance with Federal Regulations, following are reproductions of labels on, or inside the product relating to laser product safety.

KENWOOD CORPORATION
2967-3, ISHIKAWA-CHO, HACHIOJI-SHI,
TOKYO, JAPAN

KENWOOD CORP. CERTIFIES THIS
EQUIPMENT CONFORMS TO DHHS
REGULATIONS NO. 21 CFR 1040.10,
CHAPTER I, SUBCHAPTER J.

Location: Bottom Panel

For the U.S.A.

FCC WARNING :

This equipment may generate or use radio frequency energy. Changes or modifications to this equipment may cause harmful interference unless the modifications are expressly approved in the instruction manual. The user could lose the authority to operate this equipment if an unauthorized change or modification is made.

NOTE :

This equipment has been tested and found to comply with the limits for a CLASS B digital device, pursuant to Part 15 of the FCC Rules. These limits are designed to provide reasonable protection against harmful interference in a residential installation. This equipment may cause harmful interference to radio communications, if it is not installed and used in accordance with the instructions. However, there is no guarantee that interference will not occur in a particular installation. If this equipment does cause harmful interference to radio or television reception, which can be determined by turning the equipment off and on, the user is encouraged to try to correct the interference by one or more of the following measures:

- — Reorient or relocate the receiving antenna.
- — Increase the separation between the equipment and receiver.
- — Connect the equipment into an outlet on a circuit different from that to which the receiver is connected.
- — Consult the dealer or an experienced radio/TV technician for help.

Special feature

This unit is audio equipment based on the Mini Disc format. The Mini Disc (MD) is an application of the optical and magneto-optical technology and has the capability to record signals on discs. The operability of the MD is equivalent to the Compact Disc (CD). The MD uses optional non-contact system so the recordings are not degraded by eternal factors and the discs are never scratched or damaged in playback.

Convenient title search

After recording of music tracks on a Mini Disc, their title can be registered additionally. Once the titles have been registered, the desired music tracks on the Mini Disc can be played by referring to the display, not the record jacket, etc.

High-quality playback/recording

This unit incorporates a high-performance, 1-bit DAC for playback with a high sound quality. Digital recording with a high sound quality is also possible thanks to the optical input jack.

Simplified CD recording (O.T.E.)

When this unit is combined with the CD player (DP-SE7 or DP-SE9), the O.T.E. (One Touch Edit) function allows to record desired tracks with a one-touch operation.

Convenient editing features

The contents of the disc recorded by yourself can be edited as you need.

- Reordering tracks
: The order of tracks can be changed by moving them as desired.
- Dividing a track
: A single track can be split into two by inserting an additional track number.
- Combining two tracks
: Two tracks can be merged into a single track by deleting a track number.
- Erasing tracks
: Music tracks or an entire disc you do not want to listen to can be erased, or all titles are erased.

CD-TEXT display

When used in combination with a CD player (DP-SE7 or DP-SE9), the text information (disc and track titles) can be displayed on the side of this unit. Depending on the type of characters, display may not be possible.

Safety Precautions

Installation position

The MD recorder is very sensitive to vibrations. It should be installed in a position subject to as small vibration as possible.

Dust countermeasure

The shutter of the disc cartridge is permanently open while the disc is loaded in the set. Therefore, to prevent dust from penetrating inside the disc, take the disc out of the unit immediately after completion of recording or playback.

WARNING NOTICE:

IN MOST CASES IT IS AN INFRINGEMENT OF COPYRIGHT TO MAKE COPIES OF TAPES OR DISCS WITHOUT THE PERMISSION OF THE COPYRIGHT OWNERS. ANYONE WISHING TO COPY COMMERCIALY AVAILABLE TAPES OR DISCS SHOULD CONTACT THE MECHANICAL COPYRIGHT PROTECTION SOCIETY LIMITED OR THE PERFORMING RIGHTS SOCIETY LIMITED.

Beware of condensation

When water vapor comes into contact with the surface of cold material, water drops are produced.

If condensation occurs, correct operation may not be possible, or the unit may not function correctly.

This is not a malfunction, however, the unit should be dried.

(To do this, turn the POWER switch ON and leave the unit as it is for several hours.)

Memory backup

The memory storage is held for about a day after the power cord has been unplugged from the power outlet. In case the power supply has stopped or the power cord has been left unplugged for an extended period of time, the information related to recording and editing (recorded at the moment a Mini Disc is ejected) may be cleared or destroyed before it is recorded on the disc. The lost information cannot be recovered later.

To ensure the recording of the recording and editing-related information on the Mini Disc, be sure to eject the Mini Disc after every recording or editing operation.

US and foreign patents licensed from Dolby Laboratories Licensing Corporation.

What is CD-TEXT?

CD-TEXT is a standard for display of character information (disc name, track titles, artist names, etc.) recorded on a CD in addition to the music. When this unit and a CD player (corresponding to CD-TEXT) are connected by digital connection, the CD character information can be copied to the MD.

However, as of 1997, some CDs contain a copy prohibition code, so that the character information can not be copied. In such a case, the character information will be displayed on the screen, but it can not be copied.

"CD text edition" operation becomes possible for CDs without copy prohibition code.



Be especially careful in the following conditions:

- When the unit is brought from a cold place to a warm place, and there is a large temperature difference.
- When a heater starts operating.
- When the unit is brought from an air-conditioned place to a place of high temperature with high humidity.
- When there is a large difference between the internal temperature of the unit and the ambient temperature, or in conditions where condensation occurs easily.

Handling of Mini Disc

As the Mini Disc is accommodated inside a cartridge, it can be handled without caring about dust or fingerprint. However, stained or soiled cartridge may cause malfunction. To enjoy beautiful sound for extended period of time, take care on the following points.

Do not touch the disc directly.

Do not touch the disc by opening the shutter with your hand. The cartridge will be damaged if it is forced open.

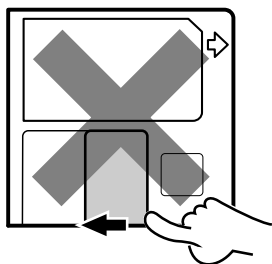

Storage position

Do not leave Mini Discs in place where the temperature and/or humidity are extremely high (for example, in a place subject to direct sunlight).

Care

Wipe periodically dust and dirt attached on the cartridge with a dry cloth.

Write protect tab

To protect recorded contents against accidental erasure, set the write protect tab of the disc open. Return the tab to the original position when you want to record signals on the disc.

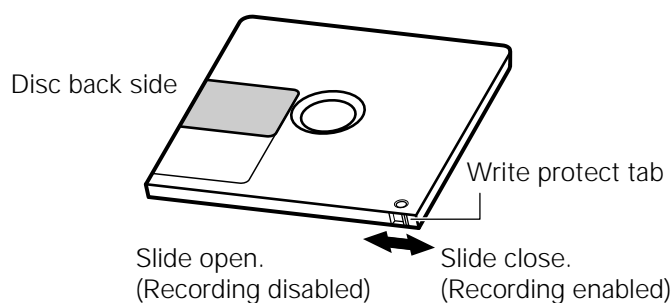

Note related to transportation and movement

Before transporting or moving this unit, carry out the following operations.

1. With no disc loaded in the unit, press the "on/standby" key to on.

- Check that no disc is present in the unit.

2. Wait a few seconds and verify that the display shown appears.

3. Press the "on/standby" key to off (standby).

NO DISC

Maintenance

Cleaning

Unplug this appliance from the wall outlet before cleaning. Do not use volatile solvents such as alcohol, paint thinner, gasoline, or benzene, etc. to clean the cabinet. Use a clean dry cloth.

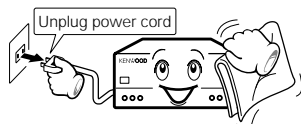

Caution against contact revitalizer

Do not use contact cleaners because it could cause a malfunction. Be specially careful against contact cleaners containing oil, for they may deform the plastic component.

The Mini Disc system has the features as summarized in the following.

- ① Like CD (Compact Disc), playback can be started from any position. (Random access)
- ② It uses a disc with a diameter of 64 mm that is accommodated in a cartridge.
- ③ Two types of discs can be used. (playback only discs, recordable / playable discs).
- ④ Up to 74 minutes of recording or playback is possible using high-efficiency coding technology.
- ⑤ Countermeasure against vibration is taken using semiconductor memory chip.

Playback-only Mini Disc

This type of MD can be used only for playback, and is used by the commercially-available music MD software packages. The playback-only MD is an optical disc like the Compact Disc (CD). The signals are recorded as the presence or absence of small pits and read out by an optical, non-contact pickup.

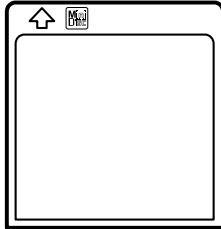

Recordable Mini Disc

This MD is a magneto-optical disc which can be recorded by magnetic field modulation. To record signals, laser light is irradiated from the bottom side of the magneto-optical disc and magnetic field is applied from the upper side of it.

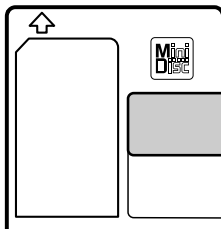

High-efficiency coding technology "ATRAC" (Adaptive TRansform Acoustic Coding)

The Mini Disc has only a half the size of the Compact Disc but provides the same recording time. This is made possible by ATRAC*, a newly developed high-efficiency coding technology.

The ATRAC compresses the music data to about 1/5 the amount of data which would be obtained with conventional technology, by cutting off the sound components which do not pose problem in audition even when they are not present. This has made it possible to record or play up to 74 minutes.

Sound does not affect the sensitivity of ears

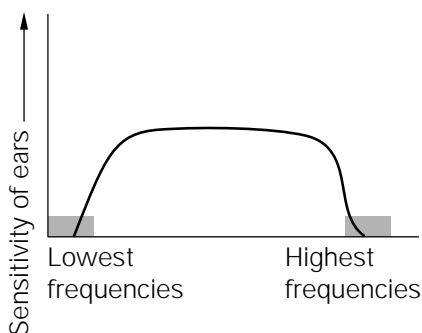

Lowest and highest frequencies are not audible unless the sound has a certain level of volume.

Small sound near large sound

A small sound is not audible to human ears if it is produced at the same time as a large sound. (Masking effect)



Sound-skip prevention memory

During playback, this unit always stores signals in memory temporarily to prevent sound from being skipped in case of vibration. As a result, even when the data from the optical pickup is interrupted due to vibration, etc., the music will not be interrupted because the memory holds the data for several seconds.

During normal playback

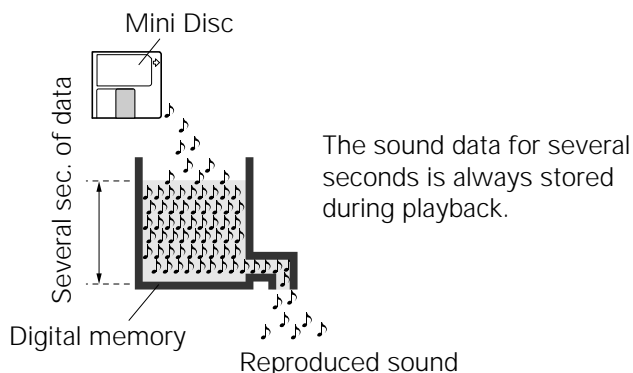

In case of vibration

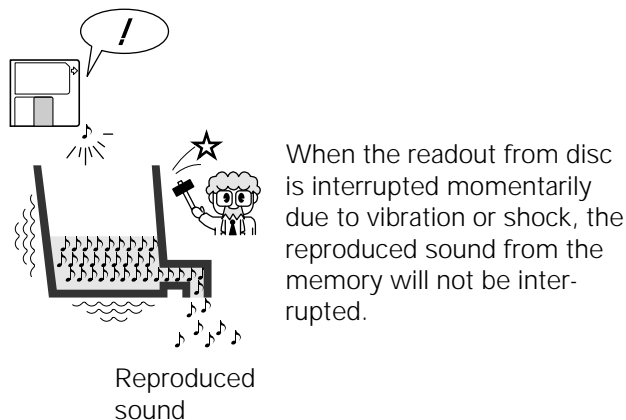

When the readout from disc is interrupted momentarily due to vibration or shock, the reproduced sound from the memory will not be interrupted.

Make connection as shown below. When connecting the related system components, refer also to the instruction manuals of the related components.

Caution: Do not plug in the power lead until all connections are completed.

Malfunction of microprocessor



If operation is not possible or erroneous display appears even though all connections have been made properly, reset the microprocessor referring to "In case of difficulty".

→ 49

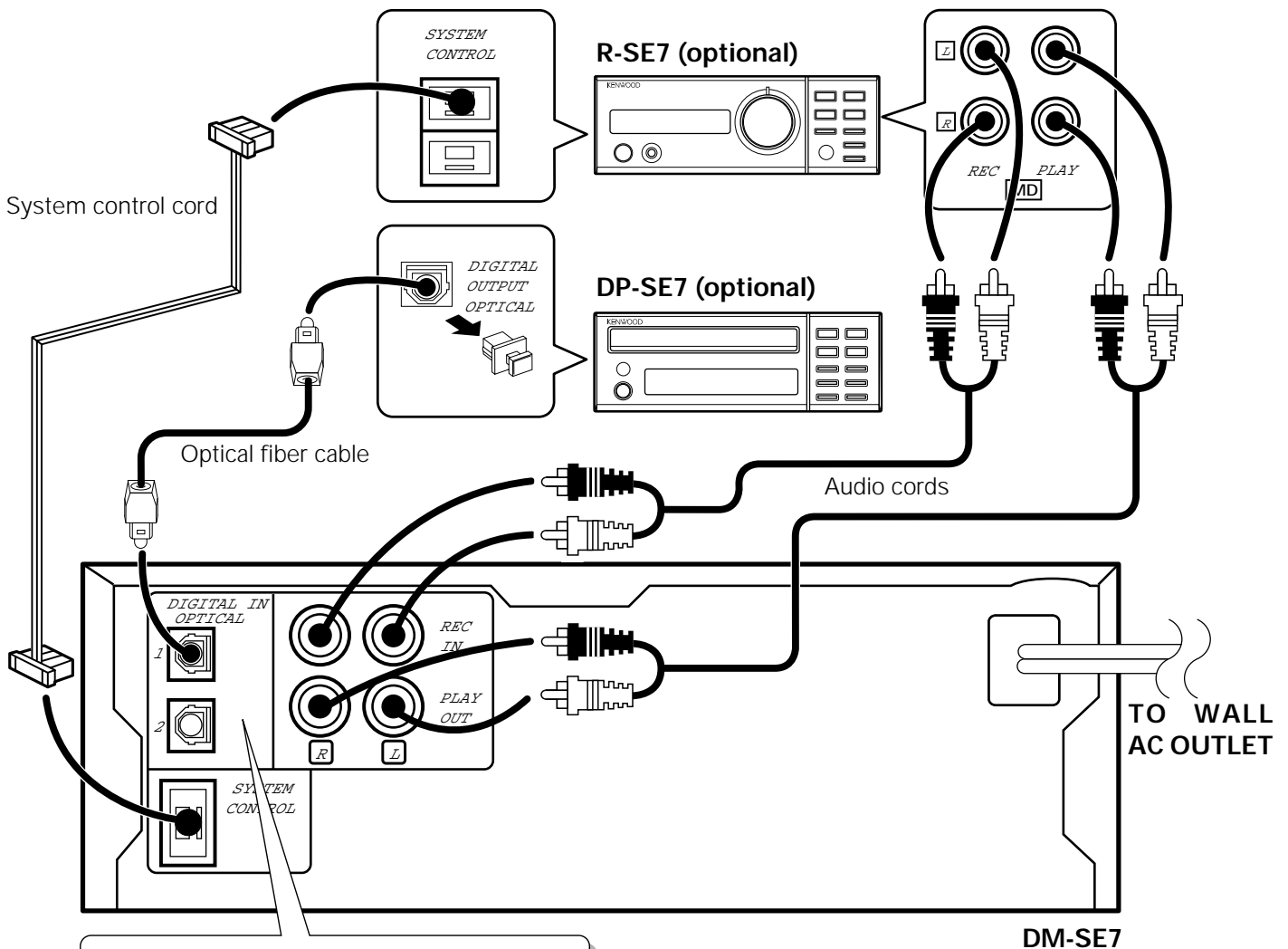

DIGITAL IN jack (OPTICAL)

Remove the protective cap before using the DIGITAL IN jack.

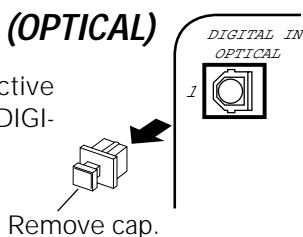

- For CD recording, the CD-TEXT function, and for positive system operation, connect the CD player (DP-SE7) to "DIGITAL IN OPTICAL 1". → 26 → 29 → 30
- Commercial digital equipment (BS tuner, DAT, etc.) can be connected to "OPTICAL 2". → 26 → 27



1. Connect all cords firmly. If connections are loose, there could be loss of sound or noise produced.
2. When plugging and unplugging connection cords, be sure to first remove the power cord from the AC outlet. Plugging/unplugging connection cords without removal of the power cord can cause malfunctions or damage to the unit.

Note on connection of optical-fiber cable

The optical-fiber cable is designed for use in the connection of the CD player (DP-SE7 or DP-SE9). The digital signal transmission makes it possible to record the high-quality sound of CDs without degradation.

- Insert the optical-fiber cable straight into the connector until it clicks.
- Be sure to attach the protection cap when the connector is not used.
- Never bend or bundle the optical-fiber cable.

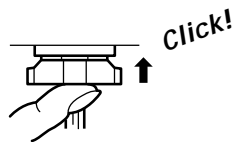
Connection of system control cord**Plugging the connector.**

Insert the connector straight until it clicks.

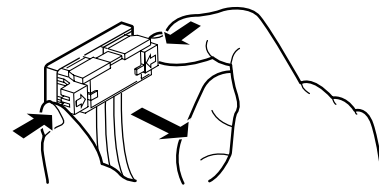
Unplugging the connector

While pushing the two sides of the connector, pull it straight out.

System operation features**Easy operation function**

When this unit is connected with the amplifier-tuner (R-SE7) via a system control cord, the basic operations of this unit can be controlled from the remote control unit provided with the R-SE7. This connection also makes possible the easy operation function which activates operations according to the input selection made on the R-SE7 (two-way operations). For details, refer to the Instruction Manual of the R-SE7.

Timer recording/playback

When this unit is connected with the amplifier-tuner (R-SE7) via a system control cord, timer playback of a disc and timer recording of radio broadcasting are possible. For details, read this instruction manual as well as the Instruction Manual of the R-SE7.

Operations on this unit: Steps **1** to **4** in "Analog recording." →  24

Display/Main unit

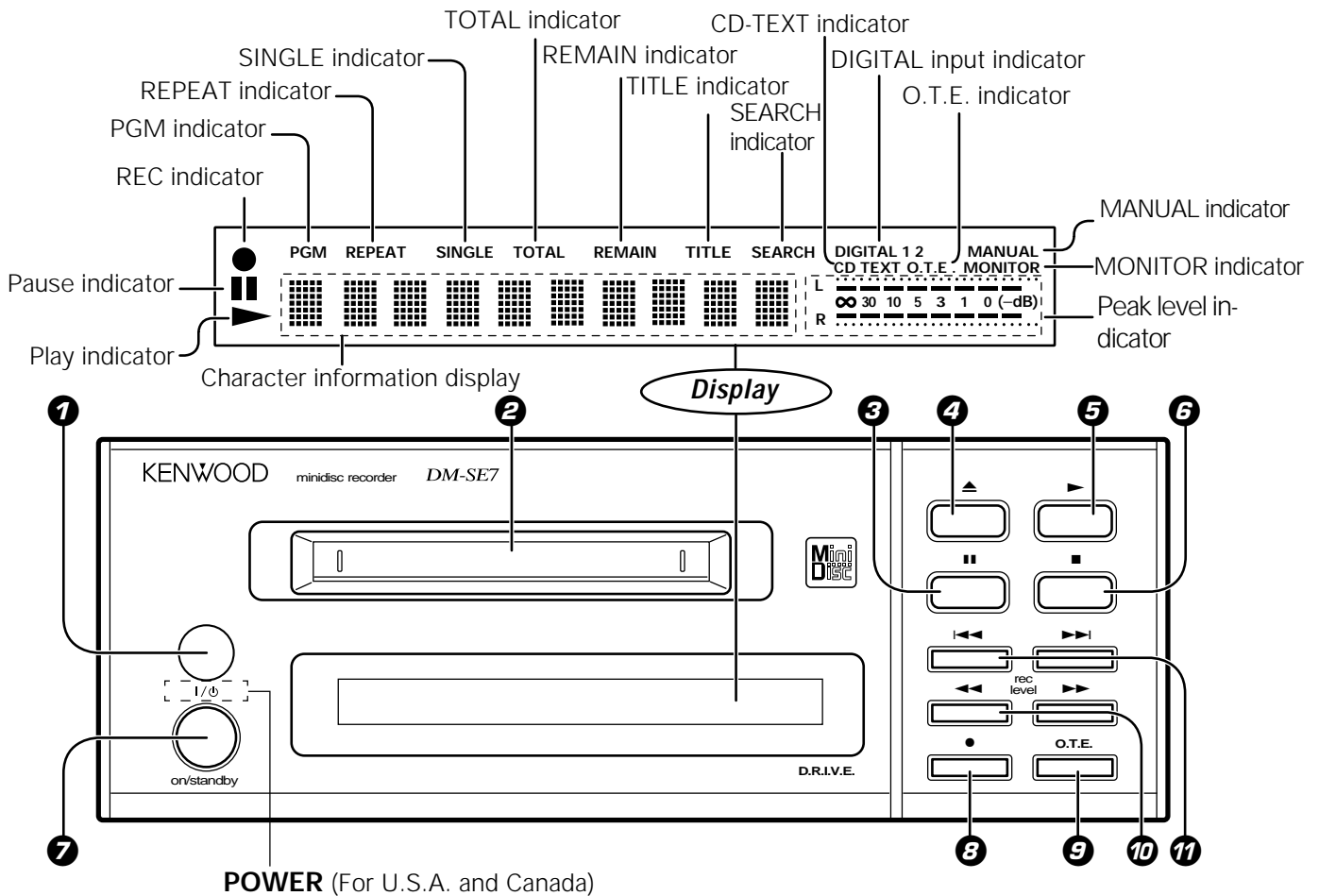

- 1 Remote control sensor** → 16
The key control signals from the remote control unit enter the main unit from here.
- 2 Mini Disc insertion slot** → 17
Insert a minidisc.
- 3 Pause (||) key** → 19
Press to temporary stop the disc operation.
- 4 Eject (▲) key** → 19
Press to unload the Mini Disc.
- 5 Play (▶) key** → 17
Press to start playback.
- 6 Stop (■) key** → 19
Press to stop the disc operation.
- 7 "on/standby (I / ⏻)" key** → 17
Press to turn the unit on or off (standby).

- 8 Record (●) key** → 25
Press when starting recording.
- 9 One-Touch Edit (O.T.E.) key** → 29
Use this key to record the track being from a CD immediately.
- 10 Fast forward and fast backward (◀◀, ▶▶) / rec level keys** → 19
During playback, this key is used to move the played position forward or backward.
During recording, this key is used to adjust the recording level. → 24
At the time of editing, the cursor movement and the selected title can be confirmed. → 31 → 34 → 40 → 45
- 11 Skip (◀◀, ▶▶) keys** → 19
Press to skip disc tracks during playback.
During editing, this key is used to select track numbers, title and characters. → 32 → 44 → 45

About the STANDBY mode

While the STANDBY indicator is lit on the display, a small amount of power is supplied to the system to back up the memory. This is called the standby mode. Under that condition, the system can be turned ON by the remote control unit. Please also refer to the description in "Memory backup."

Remote control unit

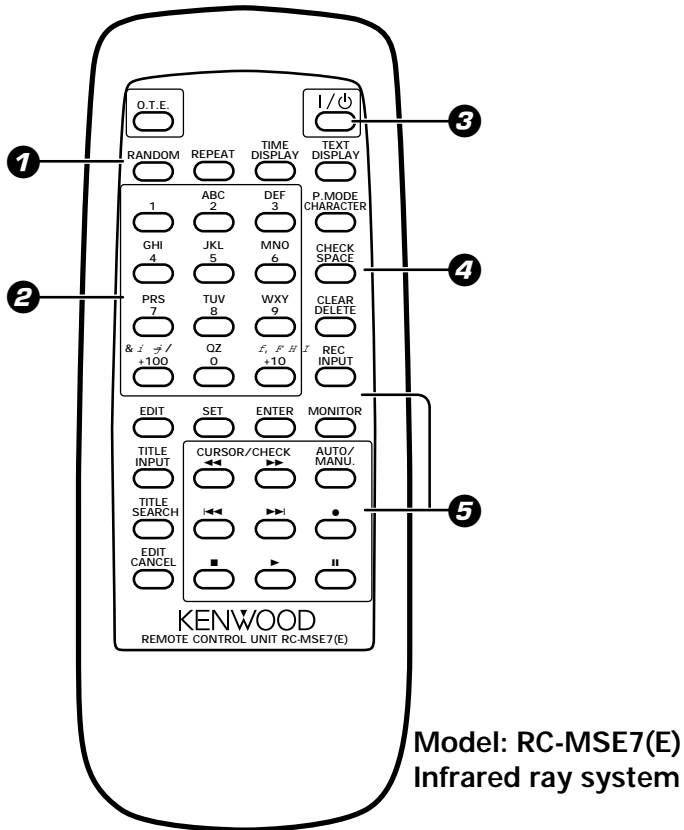

Model: RC-MSE7(E)
Infrared ray system

1 Display/recording operation keys

- One-Touch Edit (O.T.E.) key** → 29
: Press to record immediately the track being played from a CD.
- RANDOM key** → 18
: Used at the time of random playback.
- REPEAT key** → 23
: Press to play tracks repeatedly.
- TIME DISPLAY key** → 30
: Press to switch the time display mode.
- TEXT DISPLAY key** → 30
: The CD-TEXT disc title or track title is displayed.

2 Numeric keys

- : Press to specify the desired track number. → 18
: Used at the time of title input for selection of characters and symbols. → 45 → 46

3 on/standby (I / ⏻) key

- : Press to turn the unit on or off (standby).

4 Program operation keys

- P.MODE (Play mode)/CHARACTER key** → 21
: This key is used in program playback. During title input, it is used to select the character group.
- CHECK/SPACE key** → 22
: This key is used to check the program contents. During title input, it is used to insert a blank space character.
- CLEAR/DELETE key** → 22
: This key is used to clear the program. During title input, it is used to delete a character.

5 Basic operation/applied operation keys

- Basic operation keys**
- CURSOR/CHECK**
◀▶ : Fast forward and fast backward keys. → 19
(Same function as the keys on the main unit.)
◀▶ : Skip keys. → 19
(Same function as the keys on the main unit.)
- : Record key ■ : Stop key
▬ : Pause key ▶ : Play key
- AUTO/MANU. key** → 24 → 25
: This is used for selection of automatic (AUTO) or manual (MANU.) track number assignment at the time of recording.

Applied operation keys

- REC INPUT (Recording input) key** → 24
: This key is used to switch the recording input source.
- EDIT key** → 32
: This key is used to switch the editing mode.
- SET key** → 32
: Press to set the editing result or input title definitely in memory.
- ENTER key** → 33
: Press to execute editing or title input operation.
- MONITOR key** → 27
: The sound of the unit connected to "DIGITAL 2" is heard.
- TITLE INPUT key** → 44
: This key is used to switch the title input mode.
- TITLE SEARCH key** → 20
: This key is used to switch the title search mode.
- EDIT CANCEL key** → 33
: Used to cancel editing.

Loading batteries

1 Remove the cover.

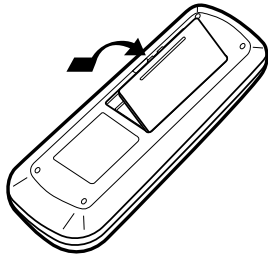

2 Insert batteries.

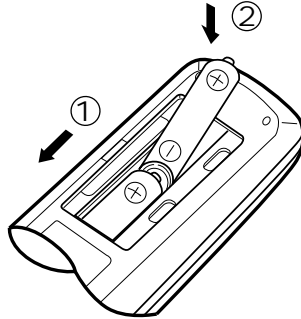

3 Close the cover.

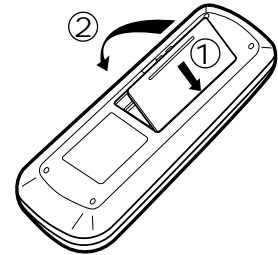

- Insert two R6 ("AA"-size) batteries following the polarity indications.

Operation

The unit can be turned on by plugging the power cord into a power outlet and pressing the "on/standby (I / ⏻)" key of the remote control unit. After the unit has been turned on, press the desired operation key.

- When pressing more than one remote control keys successively, press the keys securely by leaving an interval of 1 second or more between pressing of keys.

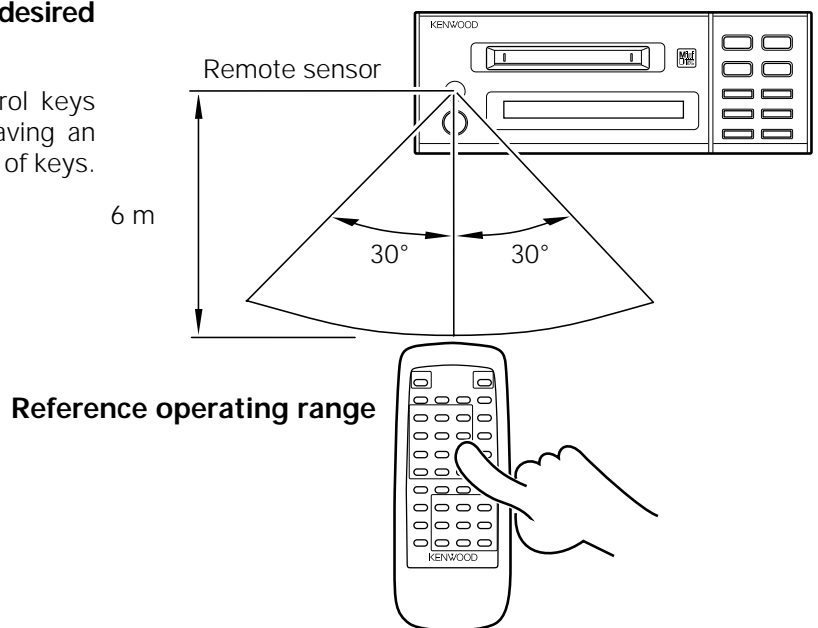

1. The provided batteries are intended for use in operation checking, and their service life may be short.
2. When the remote controllable distance becomes short, replace both of the batteries with new ones.
3. If direct sunlight or the light of a high-frequency fluorescent lamp (inverter type, etc.) is incident to the remote sensor, malfunction may occur. In such a case, change the installation position to avoid malfunction.

Use the following procedure to play a MD in the original order of tracks from track No. 1.

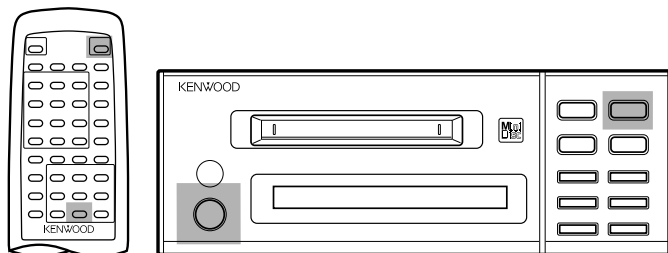

: Keys and control used in the operations described on this page.

Playing tracks in order from track No. 1

1 Turn the unit ON.

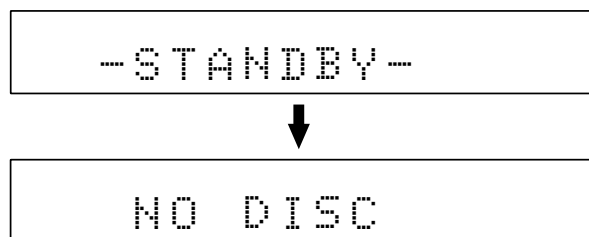
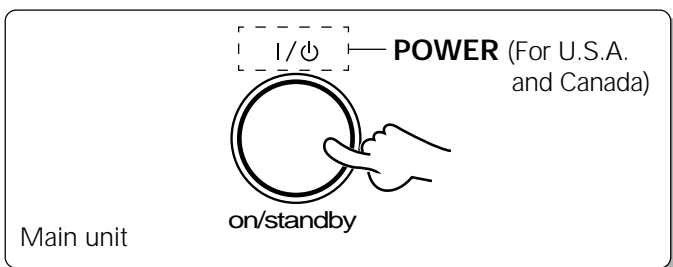

In case no disc is loaded:

2 Load a Mini Disc.

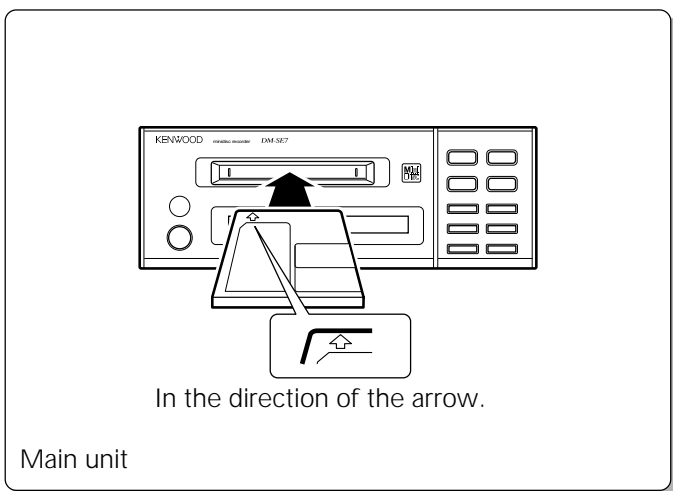

- Insert the minidisc correctly into the slot of this unit.
- **"READING"** blinks while the unit checks the contents of the disc.
- If a title has been assigned to the disc, that title will be displayed.

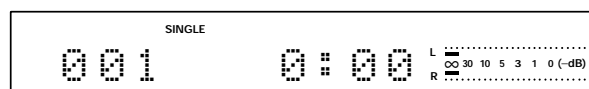

3 Start playback.

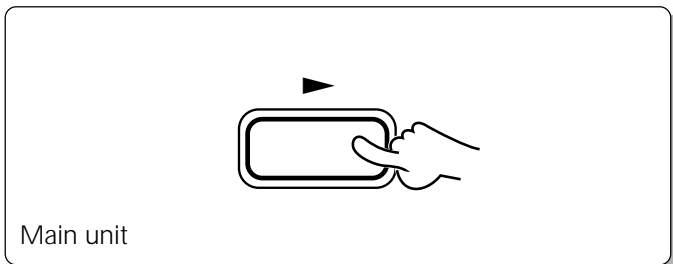

- In a few seconds, playback starts from track No, 1.

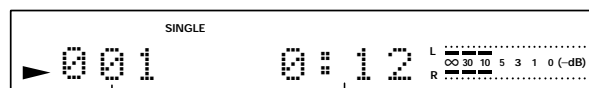

Track No. being played

Elapsed time of track being played

Playback from desired track

1 Let the "PGM" indicator go off.

Operate in stopped condition.

P.MODE
CHARACTER



"PGM" goes off

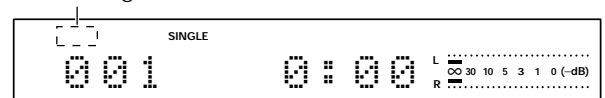

- If the "PGM" indicator is lit, press the **P.MODE/CHARACTER** key of the remote control unit to turn it off.

2 Select the desired track number.

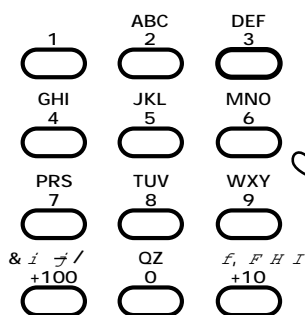

Press the numeric keys as shown below...

To enter track No. 23 :

[+10], [+10], [3]

To enter track No. 40 :

[+10], [+10], [+10], [+10], [0]

To listen from an intermediate position of a track :

Listening from the middle of track 7 (7.5)

: Press [7], [0], [5] in this order.

Listening from an intermediate position of the title being played (.3)

: Press [0], [3] in this order.



Example : Specification is possible in the range from [1] to [9].

Listening in random order (RANDOM playback)

As the title each time will be selected at random, you can listen for a long time without getting bored.

Operate in stopped condition.

RANDOM



To select a different title during listening :

Press the ►► key.

Disc recorded in monaural mode

This unit is capable of playing a disc recorded in the monaural mode.

As the amount of data required to record information in the monaural mode is half the amount required in the stereo mode, the play (record) time of a disc recorded in the monaural mode is twice (max. 148 minutes) as that of a disc recorded in the stereo mode.

Skipping tracks

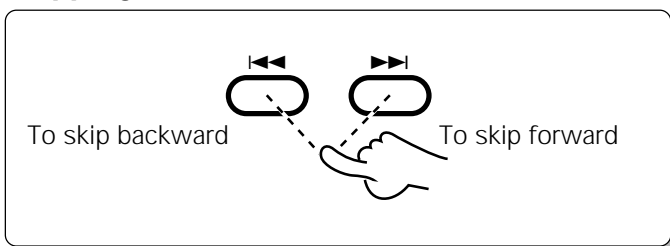

- The track in the direction of the pressed button is skipped, and the selected track will be played from the beginning.
- When the **◀◀** key is pressed once during playback, the track being played will be played from the beginning. (If it is pressed within 2 seconds from the start of a track, the previous track to the current track will be played from the beginning.)

Searching in a track

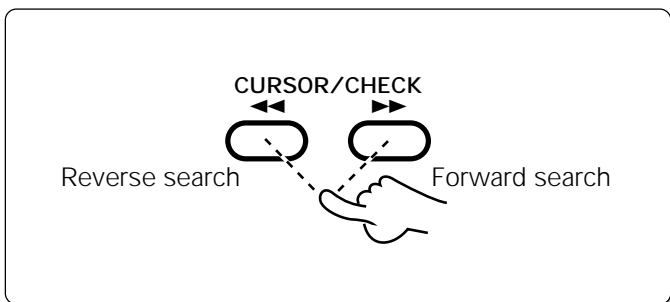

- Playback restarts from the position with which the key is released.
- If forward or reverse search is started during play-pause, the disc can be searched at a high speed but sound is not output.
- When the reverse search is started during the program mode and the beginning of the current track is attained, it will be played from the beginning. → 21

To pause playback

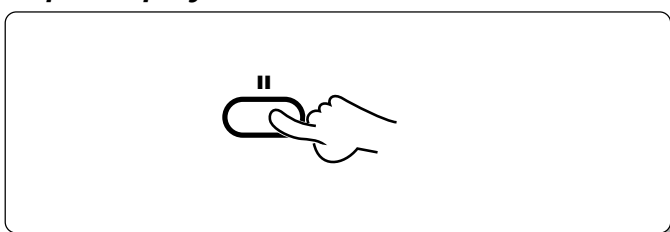

- Each press pauses and plays the MD alternately.

To stop playback

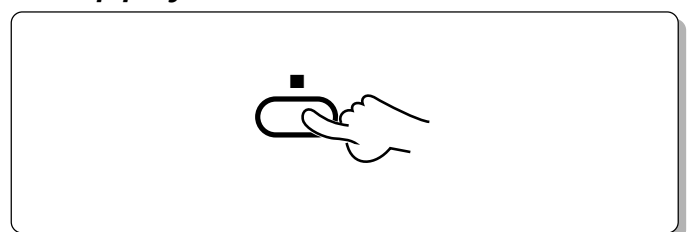

Ejecting the disc

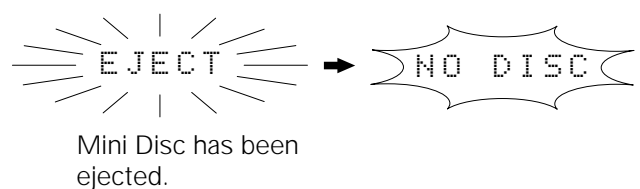
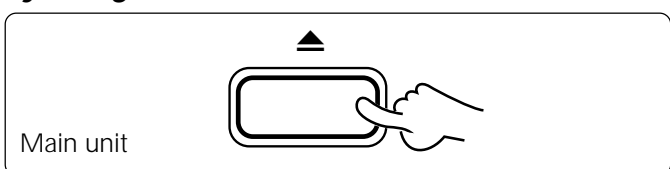

Preparation ● Let the "PGM" indicator go off.

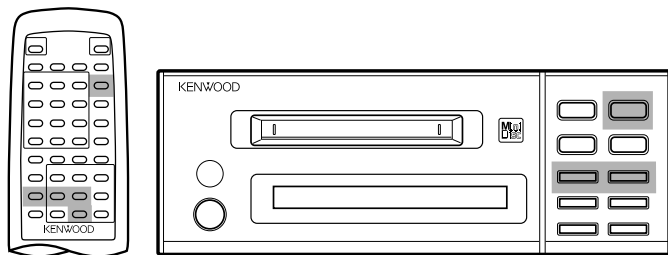

: Keys and control used in the operations described on this page.

Searching a desired track by its title (TITLE SEARCH)

1 Press the TITLE SEARCH key.



To abort operation, press the **TITLE SEARCH** key again.

"PGM" goes off

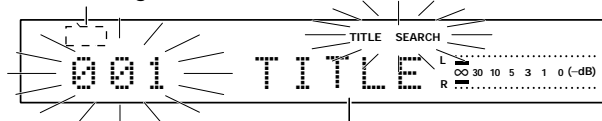

Characters flow toward the left.

- With a track to which no title has been assigned, the track number and "•••••" are displayed.

2 Select the desired title.

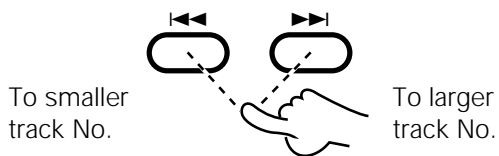

Track played

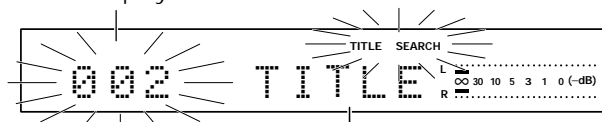

Title

3 Start playback.

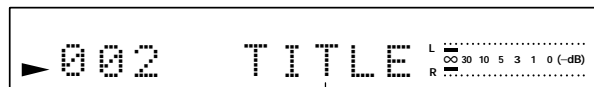



Characters flow toward the left.

Use the following procedure to program desired tracks in a desired order. (up to 32 tracks)

Preparation

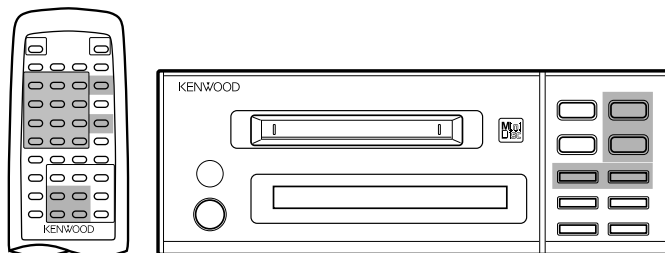
- Load a disc.
- Enter stop mode.



 : Keys and control used in the operations described on this page.

Programming tracks in a desired order

1 Let the "PGM" indicator light.

P.MODE
CHARACTER



"PGM" lights up

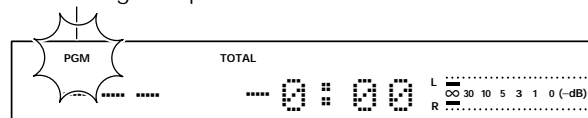

2 Select track numbers in the order you want to play them.

1 Select the track number to be played.

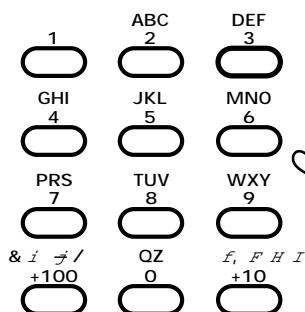

2 Set the input track number.

P.MODE
CHARACTER



3 Repeat steps 1 and 2 above.

Press numeric keys in the following order.

To select track No. 12: Press in order of **[+10]**, **[2]** then the **P.MODE/CHARACTER** key.

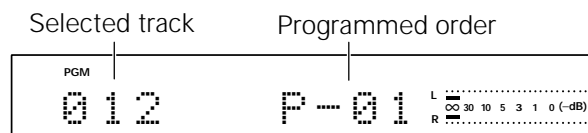

- Up to 32 tracks can be programmed. More than 32 tracks cannot be selected.
- If you made a mistake, press the **CLEAR/DELETE** key and enter the track No. again.
- An extremely short track cannot be programmed.
- "- * * : * *" is displayed when the total programmed period has attained 256 minutes or more.
- The input operation is aborted if the **P.MODE/CHARACTER** key is not pressed while the track number indicator is blinking.

3 Start playback.



- When the **⏮** or **⏭** key is pressed during playback, tracks will be skipped in the direction of the pressed key.

To add a track to the program

Operate in stopped condition.

1 2 3
 ABC DEF
 4 5 6
 GHI JKL MNO
 7 8 9
 PRS TUV WXY
 & i / / QZ L, F H I
 +100 0 +10

P.MODE CHARACTER

- When a track No. is selected, the track will be added to the end of the existing program.
- The input operation is aborted if the **P.MODE/CHARACTER** key is not pressed while the indicator is blinking.

Checking the order of tracks

CHECK SPACE

"PGM" blinks Programmed order

PGM 014 P-03
 L ∞ 30 10 5 3 1 0 (-dB)
 R ∞

- Each press displays the next track in the program.

To clear tracks from the program (Operate in stopped condition.)

Clearing tracks from the end

CLEAR DELETE

Clearing all tracks

P.MODE CHARACTER
 Remote control unit or Main unit

(Example when P-14 has been cleared)

PGM
 --- --- --- P-14
 L ∞ 30 10 5 3 1 0 (-dB)
 R ∞

- The entire program is cleared.

Preparation ● Enter stop mode.

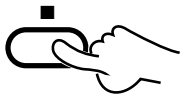

Repeated playback

To repeat only the programmed tracks

1 Program the tracks to be repeated.

① Let the "PGM" indicator light.



② Select the desired track.

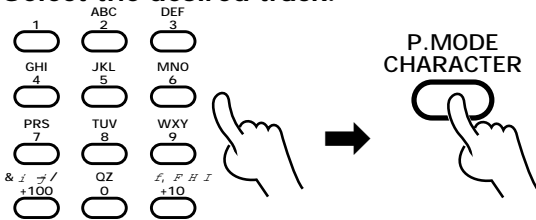

2 Repeat step ② above.

3 Let the "REPEAT" indicator light.



4 Start playback.



"PGM" lights up

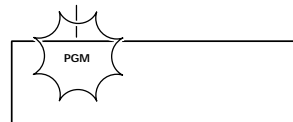

- All of the programmed tracks will be repeated.
- In case only one track is programmed, only that track will be repeated.

"REPEAT" lights up

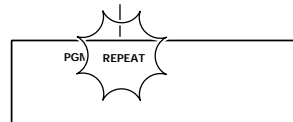

To stop repeated playback

Press the REPEAT key again.

To repeat the entire disc

1 Let the PGM indicator go off.



2 Let the "REPEAT" indicator light.



3 Start playback.



"PGM" goes off "REPEAT" lights up

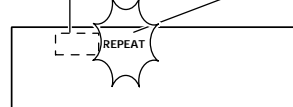

To stop repeated playback

Press the REPEAT key again.

The input jacks connected with audio cords accept analog signals. This unit records the analog signal from the REC IN jacks by converting it into digital signal. (This recording is simply referred to as analog recording.)

- Preparation**
- Open the write protect tab of the Mini Disc to make it recordable. → 9
 - Load the Mini Disc.
 - Check the remaining recording time. → 30

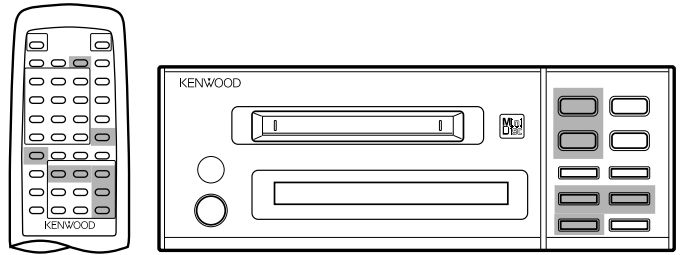

■ : Keys and control used in the operations described on this page.

Analog recording

1 Set the amplifier's input selector to the source to be recorded.

2 Select "ANALOG" or "MONO".

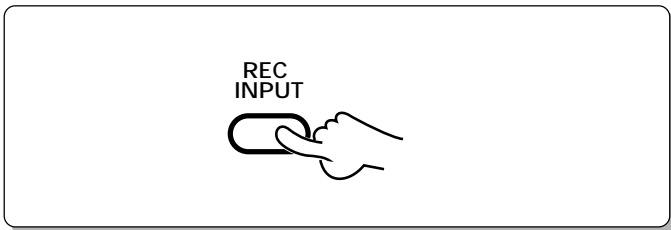

3 Select "AUTO" or "MANUAL".

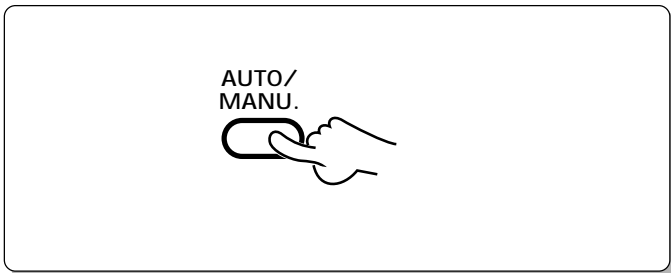

4 Adjust the recording level.

- 1 Play the source to be recorded.
- 2 Press the ● key.
- 3 Adjust the recording level.

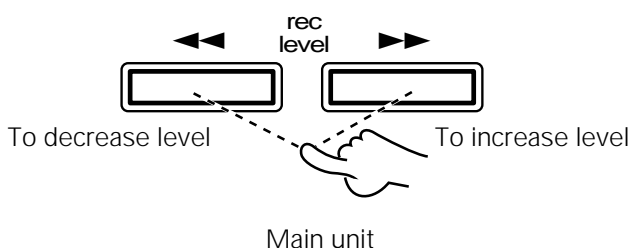

Each press switches the mode.

- 1 ANALOG : Analog "stereo" mode.
- 2 DIGITAL 1 :
- 3 DIGITAL 2 :
- 4 MONO : Analog "mono long-time" mode.

Goes off when "MONO" is selected. goes off



- When "MONO" is selected, the sound of the input source is recorded with mixing of left and right channel. Recording is possible for about twice the time of a stereo recording.

Each press switches the mode.

- 1 goes off (AUTO) : Track numbers are added automatically. → 25
- 2 MANUAL : Track numbers are added manually. → 25

Extinguished in "AUTO" mode, lit in "MANUAL" mode.



- When the ● key is pressed, the recording automatically is paused.

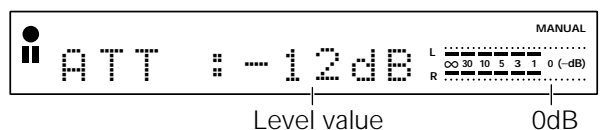

- Adjust so that the 0 dB segments of the level meter light occasionally.
- Decrease the level if the red segments of the peak level meter light.
- The recording level can be adjusted with the ◀◀ and ▶▶ keys of the remote control unit.

5 Start recording.



Pressing the pause (II) key also allows to cancel record-pause mode and start recording.

6 After recording, eject the Mini Disc. (Main unit only)

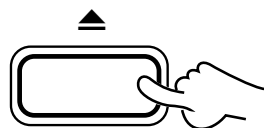

Recording is not possible if the following characters are displayed.

- “DISC FULL” : Disc is full
➔ Erase undesired tracks. → [40](#)
- “PROTECTED” : The accidental erasure protect tab is open.
➔ Close it. → [9](#)
- “PLAY ONLY” : A playback-only Mini Disc is loaded.
➔ Load a recordable Mini Disc. → [10](#)



Information is being written.

Mini Disc has been ejected.

- The eject key is not accepted during recording.



While “WRITING” is displayed, do not impact or move the unit because information about recording and editing is being written to the Mini Disc.

AUTO/MANU. key

This key is used to select whether track numbers are to be marked automatically during recording or they are to be marked manually during or after recording. The track numbers can be used to locate the beginning of a track during playback or programming tracks.

Select before starting recording.

AUTO/
MANU.



Extinguished in “AUTO” mode, lit in “MANUAL” mode.

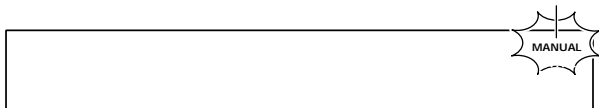

AUTO

If a no-sound input has lasted for 2 seconds during recording, the track number will be incremented automatically by “1”. Usually, use this position for recording. Use this mode when recording all of the tracks in a CD. When recording music containing a continuous section with a very low level, for example when recording classic music, the track number may be incremented by “1” after such a section. In this case, cancel the track number later. It is recommended to use the MANUAL mode when recording such a kind of music.

At the time of digital recording, the track number automatically is incremented by one on the basis of the information of the digital signal. There is no detection of unrecorded parts. A track without sound can be produced by stopping the CD on the playback side.

MANUAL

The signal is recorded without automatic incrementation of track numbers. A track number can be assigned during recording (press the **EDIT** key) or after recording (operate the TRACK DIVIDE function → [36](#)).

This position is convenient when recording live sound or classic music containing long pianissimo sections onto disc.

When this unit and CD player are connected with an optical fiber cable, the digital signal input through the DIGITAL IN (OPTICAL) jack can be recorded in a digital form (this recording is hereinafter referred to as digital recording). Enjoy high sound quality of digital recording.

Preparation

- Load a CD in the CD player.
- Open the write protect tab of the Mini Disc to make it recordable.
- Load the Mini Disc.
- Check the remaining recording time.
- Select the CD input on the amplifier.

→ 9

→ 30

Digital recording

1 Select the "DIGITAL 1 (or 2)".

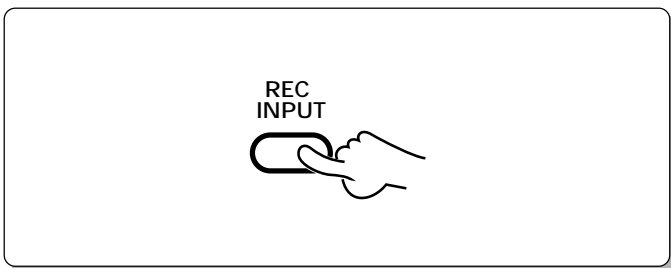

Each press switches the mode.

- ① ANALOG
- ② DIGITAL 1 : Digital mode (when the system is connected) → 12
- ③ DIGITAL 2 : (Digital mode spare)
- ④ MONO

"DIGITAL 1 (or 2)" lights up



2 Select "AUTO" or "MANUAL".

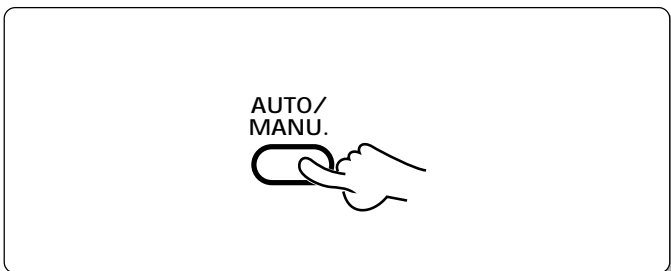

Each press switches the mode.

- ① goes off (AUTO) : Track numbers are added automatically. → 25
- ② MANUAL : Track numbers are added manually. → 25

Extinguished in "AUTO" mode, lit in "MANUAL" mode.

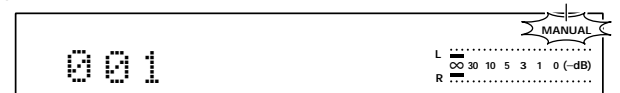

3 Start recording.

Press twice.



Recording pause



Recording start

- When the **EDIT** key is pressed during recording, a track number is inserted in that position.

Recording is not possible if the following characters are displayed.

"UNLOCK" : The sampling frequency is not 32 kHz, 44.1 kHz, 48kHz. → 28

→ Use analog recording. → 24

: The optical fiber cable is unplugged or loosened. (The connector is not connected.)

→ Connect the optical fiber cable correctly.

→ 12 → 13

"SCMS ON" : Digital recording is prohibited by SCMS.

→ 28

→ Use analog recording. → 24

"Not Audio" : The input digital signal is not an audio signal.

Also, "DISC FULL", "PROTECTED", "PLAY ONLY".

→ 25

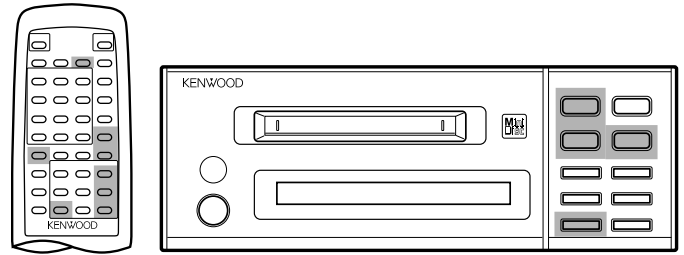

■ : Keys and control used in the operations described on this page.

4 Play the CD player.

5 After recording, eject the Mini Disc.
(Main unit only)

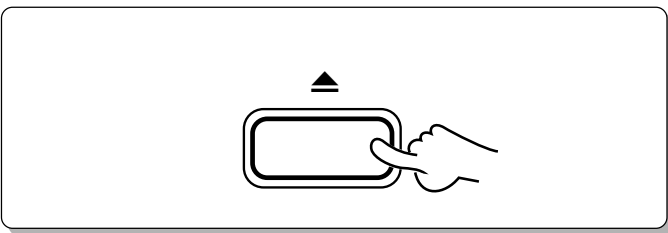

- To record music with a margin from the beginning, it is recommended to start the CD playback after the time display of the MD recorded has started the count.



Information is being written.

Mini Disc has been ejected.

Note While "WRITING" is displayed, do not apply shock or vibration to the unit because information is being written on the Mini Disc.

To pause recording

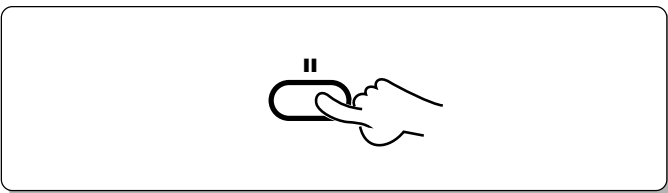

- Press the key again to resume recording. At this time, the track number is incremented by "1".
- Recording can also be started by pressing the ● key.

To stop recording

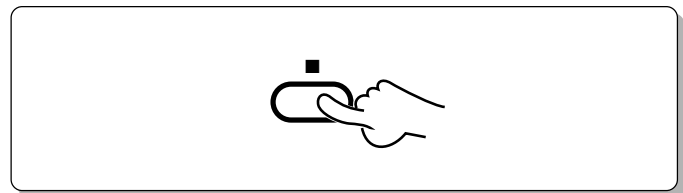

In regard to the MONITOR key

The sound of commercial digital equipment (BS tuner, DAT, etc.) connected to DIGITAL 2 can be monitored. However, when this unit is used as a general single component, the input source (sound) selected by REC INPUT can be heard.

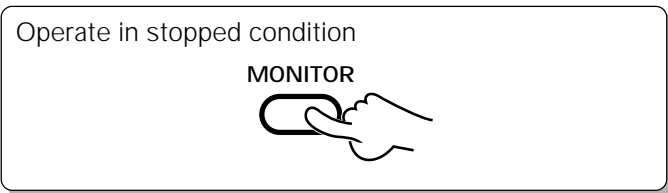

"MONITOR" Lights



- When the sampling frequency of the digital input signal is not 48 kHz, 44.1 kHz, or 32 kHz, "UNLOCK" will be displayed and no sound will be heard.

Note During CD recording, the track number is sometimes incremented by 1 when the CD starts to be played. This is caused by a signal contained in the digital signal components recorded on the CD. Unnecessary track numbers can be deleted by referring to "Erasing several tracks at a time (QUICK ERASE)" or "Erasing a single track during playback (TRACK ERASE)".

Digital recording and SCMS

Digital recording on a Mini disc is not possible under the following conditions.

- ① In case the source contains the copy prohibit code (SCMS – Serial Copy Management System).
— **“SCMS ON”** is displayed and the unit enters the record-pause mode.
- ② Locking to the reference clock is not possible. — **“UNLOCK”** is displayed and Pause status is engaged.

Sampling frequency

Three types of digital signals are usually used according to the sampling frequencies. The sampling frequencies vary depending on the types of digital equipment as shown below.

32 kHz : Standard and long-hour modes of DAT, A mode broadcasting of BS tuner, etc.

44.1 kHz : Standard mode of DAT, CD, MD, etc.

48 kHz : Standard mode of DAT, B mode broadcasting of BS tuner, etc.

(DAT : Digital Audio Tape deck)

In general, high-quality recording based on digital signal transmission is not possible unless the source and recorder components use the same sampling frequency. As this unit has a built-in sampling rate converter, digital signals with 32 kHz and 48 kHz can be recorded by conversion to the MD sampling frequency (44.1 kHz).

SCMS (Serial Copy Management System)

Designed for copyright protection, the SCMS is a prescription that copying of digital signals as they are in the digital form between digital audio equipment is allowable only for one generation.

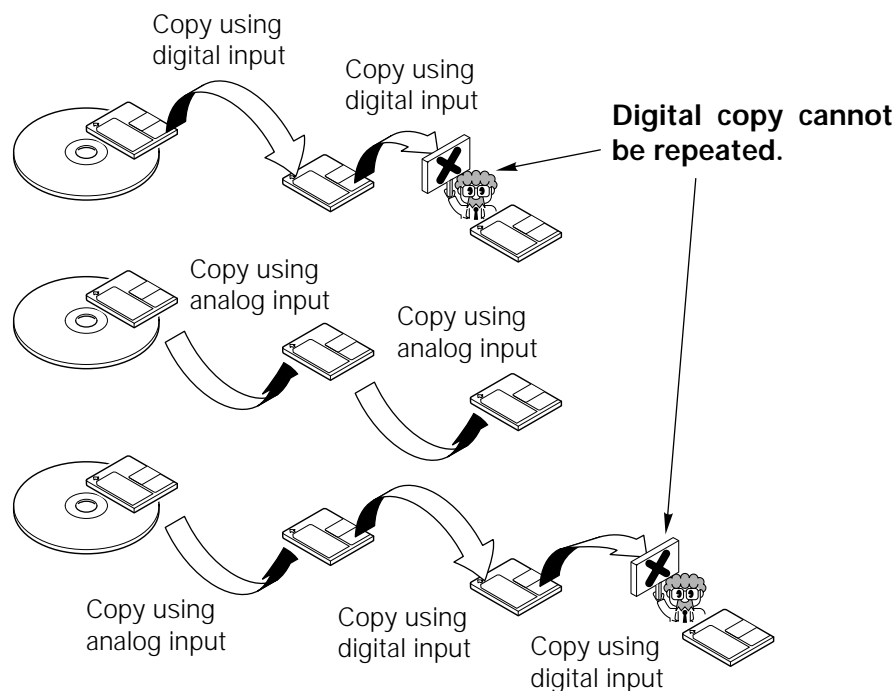

When a KENWOOD CD player equipped with a system control jack (DP-SE7 or DP-SE9) is connected to this unit via a system control cord, it is possible to select and record desired CD tracks from this unit. This function is referred to as O.T.E. (One Touch Edit). The synchronized recording with CD also possible in this configuration.

Preparation

- Connect the CD player to "OPTICAL 1".
- Select the CD input on the amplifier.
- Open the write protect tab of the Mini Disc to make it recordable.
- Load the Mini Disc.

→ 14

→ 9

Recording a single CD track (O.T.E.)

1 Play a CD.

2 Start one-touch edit recording.

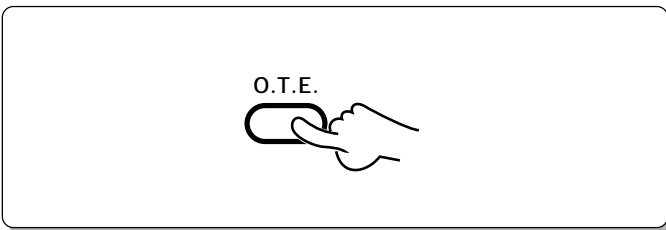

- When the **O.T.E.** key is pressed during CD playback, the track being played will be replayed from the beginning and only this track will be recorded.
- After the track has been recorded, the MD recorder stops and the CD player enters pause mode.

Press the ■ key to stop recording in the middle.

Recording all tracks on a CD (O.T.E.)

1 Stop CD playback.

2 Start one-touch edit recording.

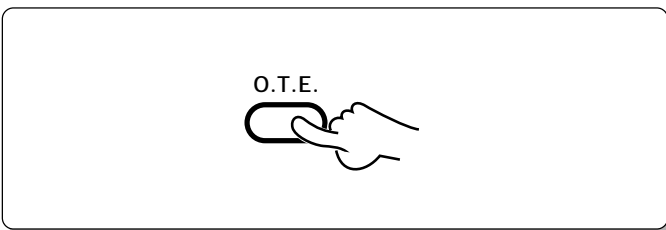

- When the **O.T.E.** key is pressed while the CD player is in stop mode, all of the tracks of the CD will be recorded.
- After all of the CD tracks have been recorded, both the MD recorder and CD player stop.

Press the ■ key to stop recording in the middle.

Synchro recording with CD player

By connecting a KENWOOD CD player equipped with a system control jack (DP-SE7 or DP-SE9) to this unit via a system control cord and starting recording with the following procedure, the recording (MD) and playback (CD) can be started simultaneously so that there is no sound interruption.

- 1 Select the CD input on the amplifier.
- 2 Put the CD player in pause mode.
- 3 Select the desired CD track with the ◀◀ or ▶▶ key.
- 4 Put the MD recorder in record-pause mode.
- 5 Start playback of the CD player.

Press the ■ key to stop recording in the middle.

TIME DISPLAY key

This key allows to switch the mode of time display.

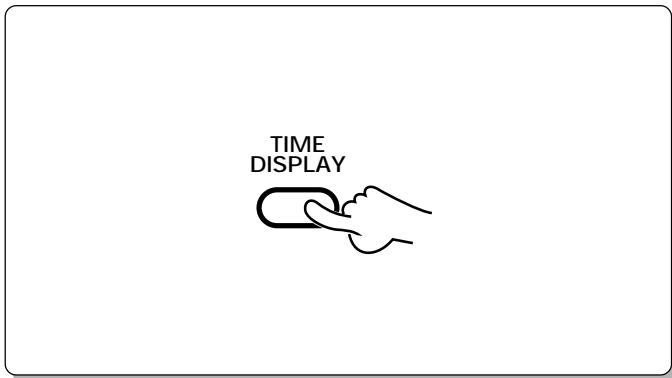

One will light.



Indication of the remaining time

Each press switches the time display modes.

- ① **SINGLE(+)** : Elapsed time of a track.
- ② **SINGLE(-)** : Remaining play time of a track.
- ③ **TOTAL(+)** : Total elapsed time of the MD.
- ④ **TOTAL(-)** : Total remaining time of the MD.
- ⑤ **REMAIN** : Remaining recording time of disc.
- ⑥ **TITLE** : Disc title indication (at the time of stop)/
Track title indication (at the time of play-back).

In record mode

- ① **SINGLE(+)** : Elapsed recording time of the track being recorded.
- ② **TOTAL(+)** : Total elapsed time at the time of recording.
- ③ **REMAIN** : Remaining recording time of disc.

- **"BLANK DISC"** is displayed if the disc does not contain any recording.
(**"NO TRACKS"** is displayed if the disc has a title.)

TEXT DISPLAY key

When a disc corresponding to CD-TEXT is inserted into a system-connected CD player (DP-SE7 or DP-SE9), the recorded text information (data) at the same time can be read in and displayed on the side of this unit.

- ① Select the CD input on the amplifier.
- ② Stop the CD and the MD.
- ③ Select "DIGITAL 1" with the REC INPUT key. → 26



- ④ Press the TEXT DISPLAY Key.

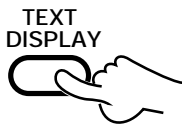

- The text information (data) is cleared when the disc is removed from the CD player or when the MD REC INPUT is switched.

Lights up

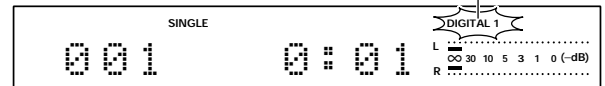

Each press switches the mode.

- ① CD TEXT flashes (CD-TEXT display mode)
- ② CD TEXT not lit (MD display mode)

Display after operation

- TEXT LOAD** : Data loading
- CAN'T LOAD** : Loading not possible → 50

"CD TEXT" blinks.

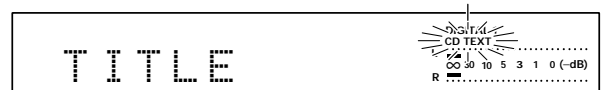

- At the time of stop** : The disc title is displayed.
- At the time of playback** : The track title is displayed.

After recording of a commercially-available recordable Mini Disc, the recording can be edited in various ways. Note that it is impossible to edit a playback-only Mini Disc.
(Editing is not possible when "PGM" is lit.)

Function Limitations because of the MD Standard
Some of the functions are limited because of the MD standard. Please check "Symptoms related to MD standard" before assuming a malfunction. → 49

Selecting the editing function type

Reordering tracks by moving them

Changing tracks during playback (TRACK MOVE) → 32
Moving several tracks at a time (QUICK MOVE) → 34

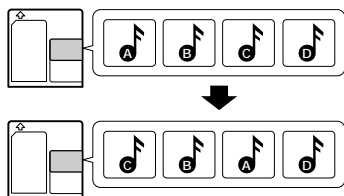

Dividing a track, combining two tracks

Dividing a track during playback (TRACK DIVIDE) → 36

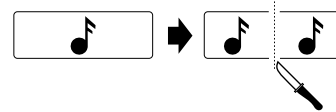

Combining tracks during playback (TRACK COMBINE) → 38



Erasing track(s)

Erasing a single track during playback (TRACK ERASE) → 42

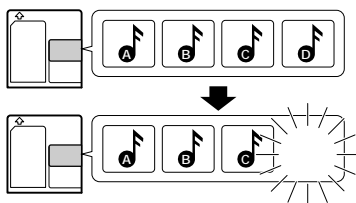

ALL ERASE → 40

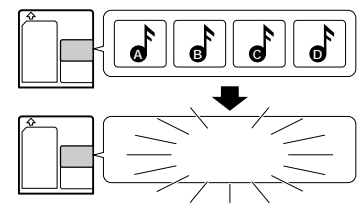

Erasing several tracks at a time (QUICK ERASE) → 40

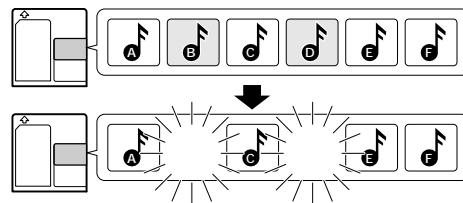

Scrolling the display

There may be cases in which the amount of information is too large to be displayed at a time during the title input operation, etc. In such a case, pressing and holding the ◀◀ or ▶▶ key allows to move the displayed characters to the left (or right) so that other information which has been hidden can be displayed. This leftward or rightward movement of the display characters is referred to as "scrolling."

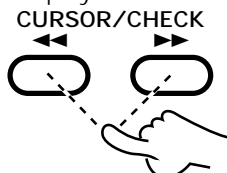

Example of scrolling

Displayed area (All cannot be displayed.)

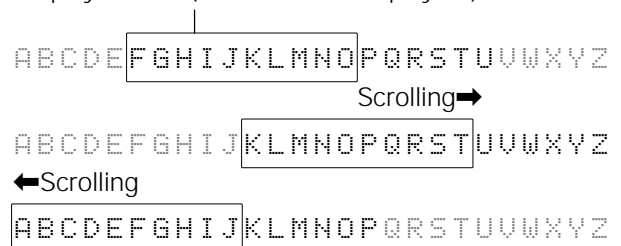

This procedure shows you how to play and move (insert) a track to the track number you desire. The surrounding tracks are renumbered automatically. Repeating this procedure lets you arrange the tracks in the order you desire.

Preparation • Play the track to be moved.

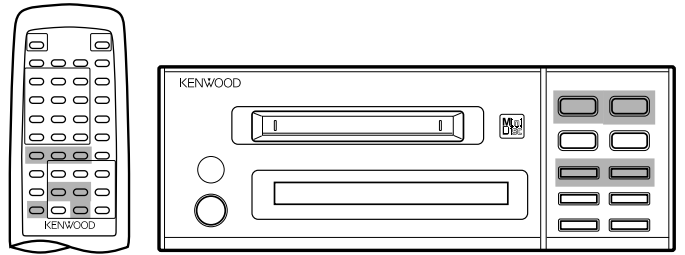

 : Keys and control used in the operations described on this page.

Changing tracks during playback (TRACK MOVE)

1 Select "MOVE".

① Press the EDIT key.



② Select "MOVE".

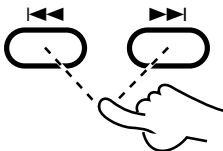

③ Set it.



Each press of the   keys switches the operation.

- ① DIVIDE?
- ② COMBINE?
- ③ ERASE?
- ④ MOVE?

• Editing is aborted if no operation has been performed for 8 seconds.

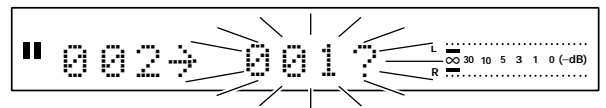
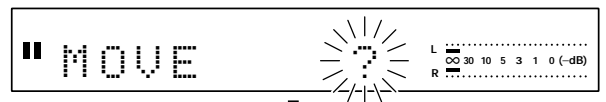

2 Select the moving destination track.

① Select the track number.

To decrease track No.

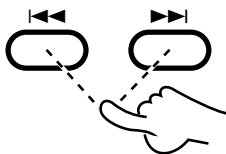

To increase track No.

② Set it.



Destination track No.



Track to be moved

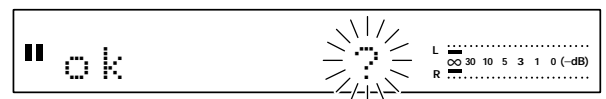

3 Execute the track reordering operation.

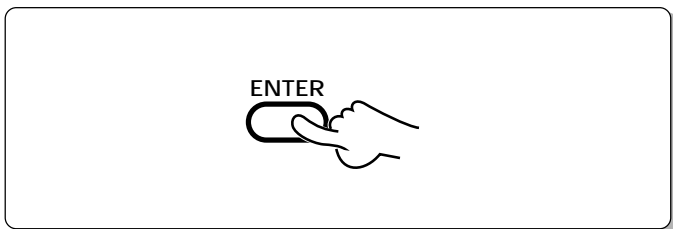

Display after execution

- “EDIT NOW !” : Editing
- “COMPLETE !” : When editing is completed successfully
- “CAN'T EDIT” : When editing is impossible

- When this operation has been performed unintentionally, return to the status before editing can be made by “EDIT CANCEL” operation. → 33

4 Eject the Mini Disc. (Main unit only)

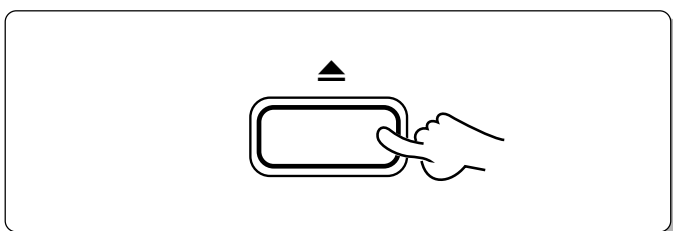

Information is being written. Mini Disc has been ejected.

Note While “WRITING” is displayed, do not impact or move the unit because information about recording and editing is being written to the Mini Disc.

To delete the edited contents (EDIT CANCEL)

When the following key operation is performed before the minidisc is removed, return is possible to the same condition as when the disc was inserted. After cancellation, again perform the individual editing operations.

Operate in stopped condition.

1

2

3

ok ?

Image of track moving

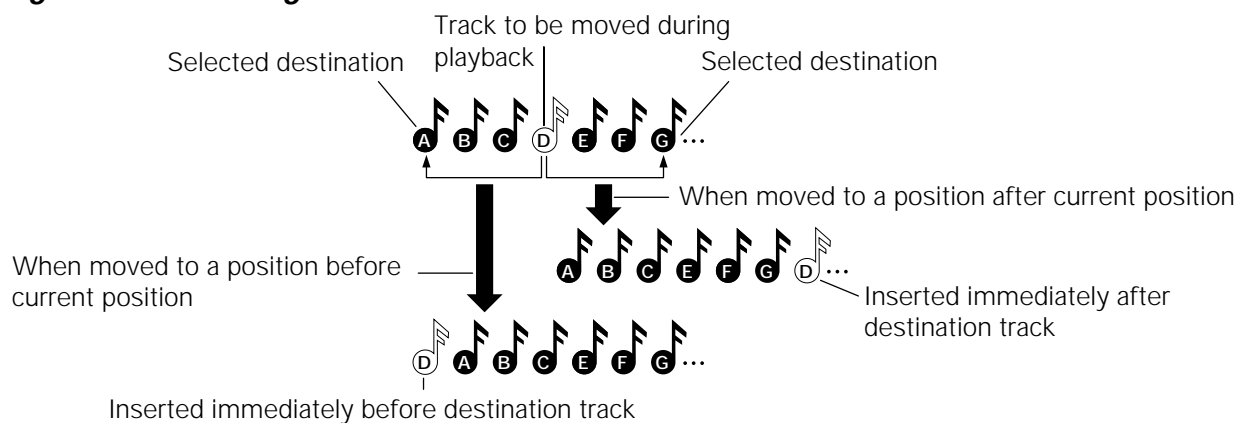

Use the following procedure to change the current order of tracks by selecting a desired order and moving the tracks together. (up to 255 tracks)

Preparation ● Enter the stop mode.

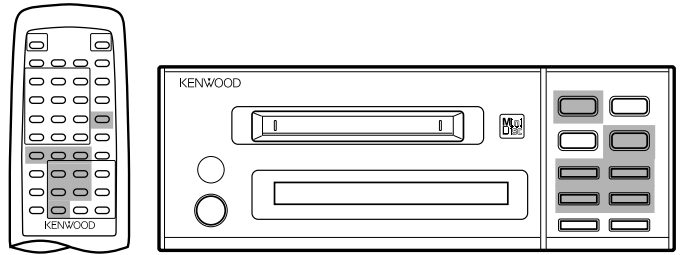

 : Keys and control used in the operations described on this page.

Moving several tracks at a time (QUICK MOVE)

1 Select the "Q.MOVE".

① Press the EDIT key .



② Select the "Q.MOVE".

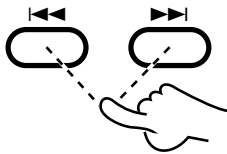

③ Set it.



Each press of the   keys switches the operation.

- ① Q.MOVE
- ② Q.ERASE

- Editing is aborted if no operation has been performed for 8 seconds.

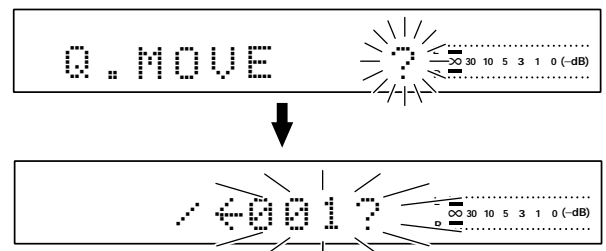

2 Select the track you want to move.

① Select a track number.

To decrease track No.

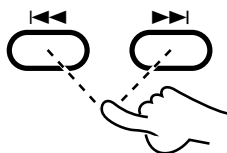

To increase track No.

② Set it.



③ Repeat steps ① and ② above.

④ End the selection of the group to be moved.



Track No. to be moved

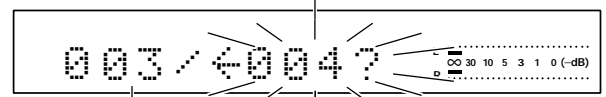

Selected track No.

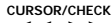
- Pressing the  key allows to check the current order of tracks.
- Pressing the **CLEAR/DELETE** key allows to cancel the last selected track only. (To erase previously selected tracks, press the **EDIT** key and restart from the beginning.)

3 Execute the track reordering operation.

1 Select the move destination.

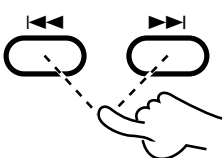

2 Set it



3 Execute the move.



Example for moving between tracks No. 4 and No. 5

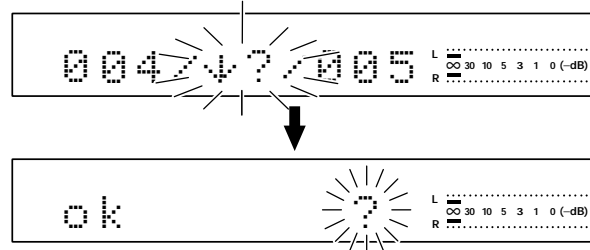

Display after execution

- “EDIT NOW !” : Editing
- “COMPLETE !” : When editing is completed successfully
- “CAN'T EDIT” : When editing is impossible

- When this operation has been performed unintentionally, return to the status before editing can be made by “EDIT CANCEL” operation. → 33

4 Eject the Mini Disc. (Main unit only)

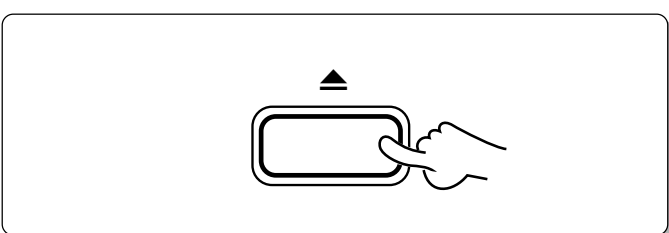

Information is being written.

Mini Disc has been ejected.

Note While “WRITING” is displayed, do not impact or move the unit because information about recording and editing is being written to the Mini Disc.

Image for moving several tracks together





Track No. Arrangement in the desired sequence (step 2)

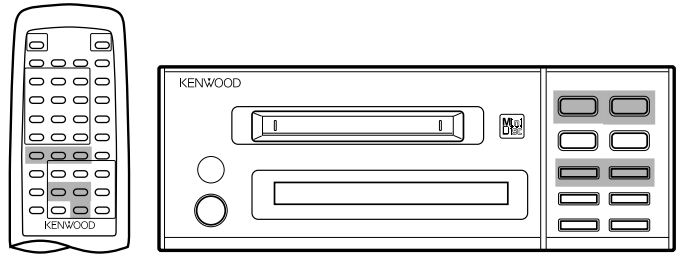

Example for moving the selected group between tracks No. 4 and No. 5 (step 3)

Use the following procedure to divide a track into two by inserting a track number in its middle. For example, by inserting an additional track number before the passage you are specially fond of, it is easy to skip to there when you play the disc later. Note that the track numbers of the tracks located after the divided track are automatically incremented. The preview function can be used for fine adjustment while repeatedly listening to the track division point.



 : Keys and control used in the operations described on this page.

Dividing a track during playback (TRACK DIVIDE)

- 1** Play the track to be divided.
- 2** Press the EDIT key at the desired position.

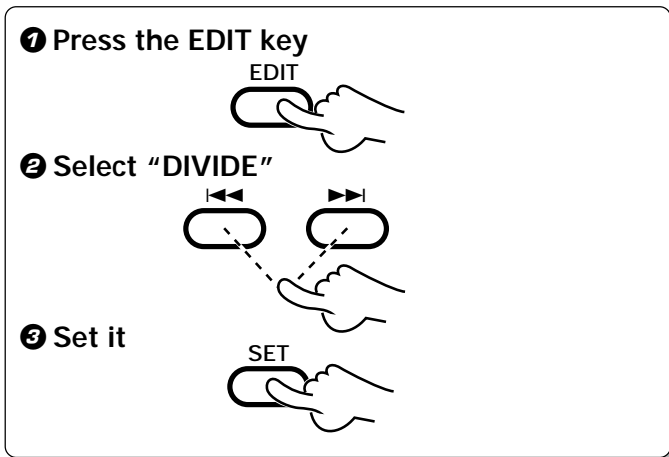

 If no preview is to be performed, press the ENTER key once and then go to step **4**.

- 3** When preview is to be performed

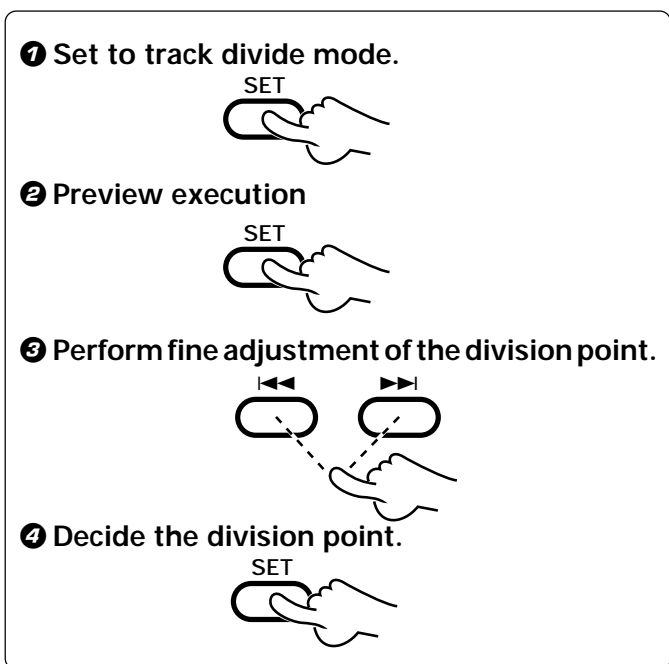

- This operation is also possible during play-pause.

Each press of the   keys switches the operation.

- ① DIVIDE?
- ② COMBINE?
- ③ ERASE?
- ④ MOVE?

- Editing is aborted if no operation has been performed for 8 seconds.

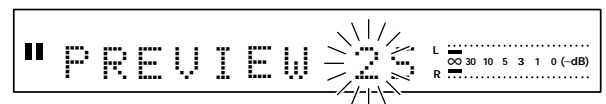
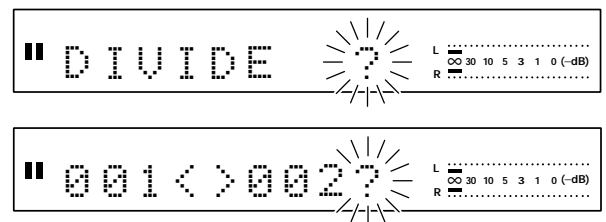

- Repeated playback from the division point will be performed for about 3 sec.



- Fine adjustment of the division point is possible from the point where the **EDIT** key has been pressed in 32 steps of 60 ms (6/100 sec) (a range of about 2 sec).

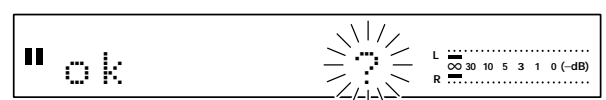

4 Execute the track divide operation.

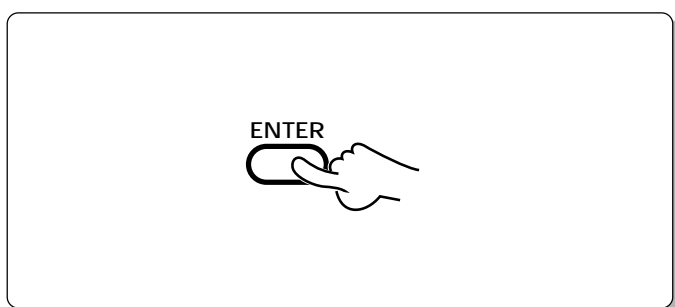

Up to 255 track numbers can be inserted additionally by repeating 1 to 4 for each of them.

5 Eject the Mini Disc. (Main unit only)

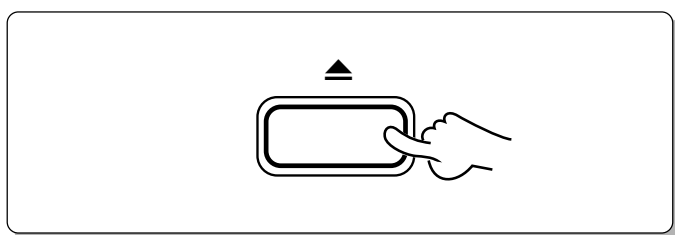

Display after execution

“EDIT NOW !” : Editing

“COMPLETE !” : When editing is completed successfully

“CAN'T EDIT” : When editing is impossible

- When this operation has been performed unintentionally, return to the status before editing can be made by “EDIT CANCEL” operation. → 33

- There is no blank space left between the two tracks.
- Track division may sometimes be impossible due to the limitations of the MD standard.



Note While “WRITING” is displayed, do not impact or move the unit because information about recording and editing is being written to the Mini Disc.

Image of track division

Should be approx. 2 sec. or longer.

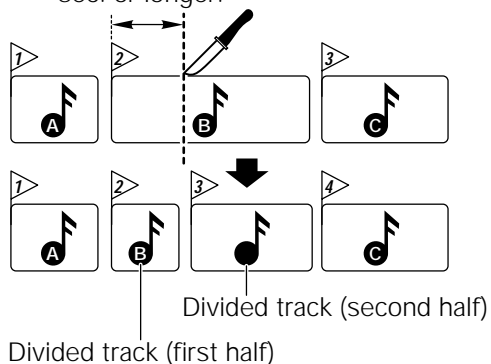
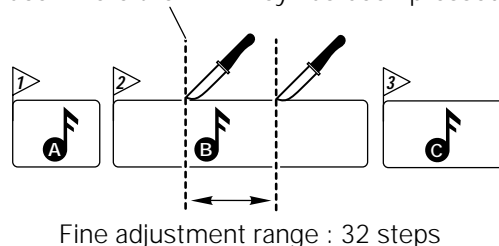
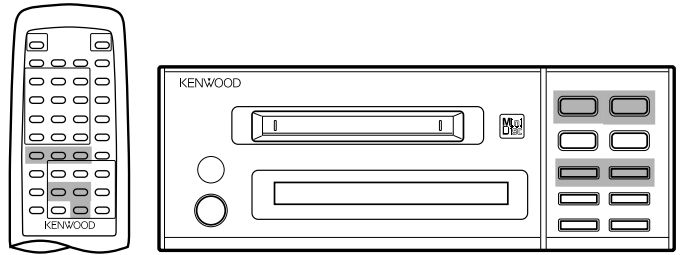



Image of preview

Place where the EDIT key has been pressed



Use the following procedure to combine two tracks into one by deleting a track number. This operation allows to connect several tracks or a piece of music divided into several parts. After this operation, the track numbers of tracks located after the combined tracks are decreased automatically.



 : Keys and control used in the operations described on this page.

Combining tracks during playback (TRACK COMBINE)

1 Play the title to be combined.

2 Select "COMBINE".

1 Press the EDIT key



2 Select "COMBINE".

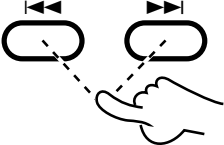



3 Set it.



 When the title being played is to be combined with the next title, press the ENTER key and then go to step **4**.

3 For combining with a different title

1 Select the track number.

To decrease track No.  To increase track No. 

2 Set it.



- If the operation is started during playback, it pauses automatically.

Each press switches the operation.

- ① DIVIDE?
- ② COMBINE?
- ③ ERASE?
- ④ MOVE?

- Editing is aborted if no operation has been performed for 8 seconds.



Present title Next title

Connecting tracks 2 and 5.

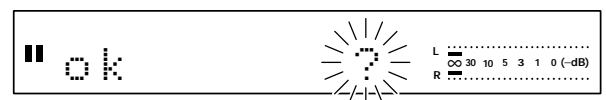

4 Execute the track combine operation.

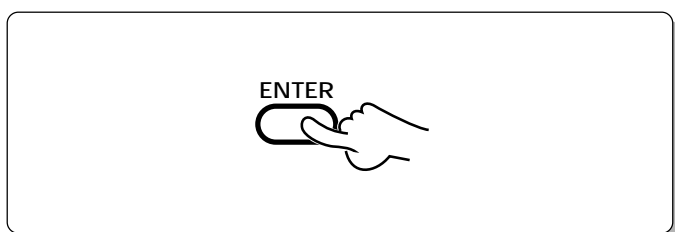

Display after execution

- “EDIT NOW !” : Editing
- “COMPLETE !” : When editing is completed successfully
- “CAN'T EDIT” : When editing is impossible

- When this operation has been performed unintentionally, return to the status before editing can be made by “EDIT CANCEL” operation. → 33
- Track combining may sometimes be impossible due to the limitations of the MD standard.

5 Eject the Mini Disc. (Main unit only)

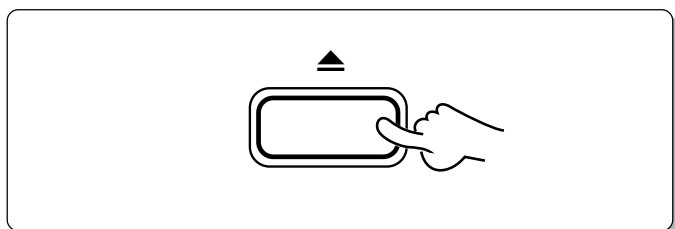

Information is being written. Mini Disc has been ejected.

Note While “WRITING” is displayed, do not impact or move the unit because information about recording and editing is being written to the Mini Disc.

Image of track combination

Should be approx. 2 sec. or longer.

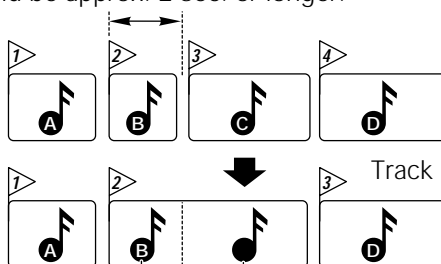

Track No. is adjusted.

Track No. and title of the second track are cleared.

Track No. and title of the first track are left.

The selected track or all tracks can be erased while the player is stop mode. Be very careful in using this function because the erased tracks cannot be recovered once the entire Mini Disc has been erased.

Preparation ● Enter the stop mode.

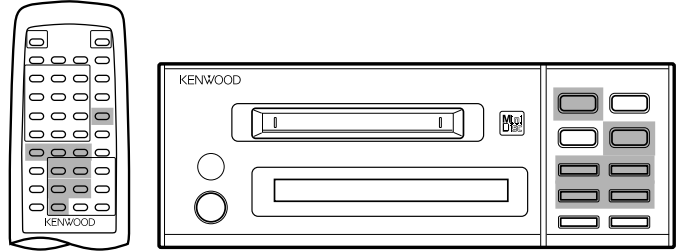

: Keys and control used in the operations described on this page.

Erasing several tracks at a time (QUICK ERASE)

1 Select "Q. ERASE".

① Press the EDIT key.



② Select "Q.ERASE".

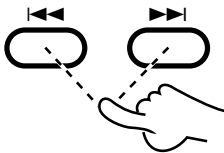

③ Set it.



Each press of the keys switches the operation.

- ① Q.ERASE?
- ② Q.MOVE?

● Editing is aborted if no operation has been performed for 8 seconds.

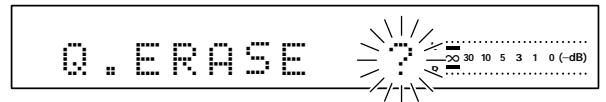

To delete all titles :
Press the SET key and the ENTER key in this order while "--<ALL?" is displayed.

● All of the tracks are erased (together with the disc title).

Refer to the right to erase all titles.

2 Select the title to be erased.

① Select the title to be erased.

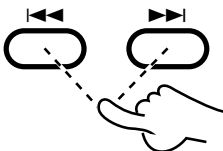

② Set it.



③ Repeat steps ① and ② above.

④ End the selection.



The title to be erased will be displayed.

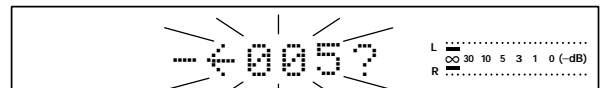

● Pressing the **CURSOR/CHECK** keys allow to check the current order of tracks.

● When the **CLEAR/DELETE** key is pressed, the title being displayed will be removed from the group of titles to be erased.

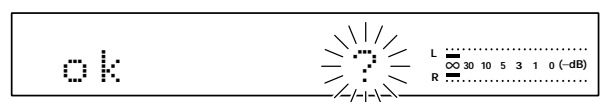

3 Execute the track erasure operation.

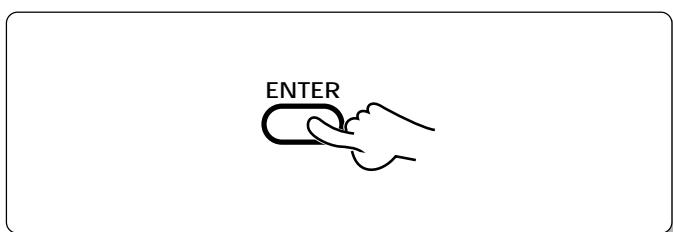

4 Eject the Mini Disc. (Main unit only)

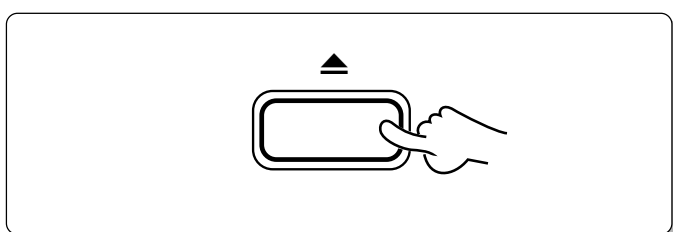

Display after execution

“EDIT NOW !” : Editing.

“COMPLETE !” : When editing is completed successfully.

“CAN'T EDIT” : When editing is impossible

- When this operation has been performed unintentionally, return to the status before editing can be made by “EDIT CANCEL” operation. → 33



Note While “WRITING” is displayed, do not impact or move the unit because information about recording and editing is being written to the Mini Disc.

Image of erasing all tracks on a disc (ALL ERASE)

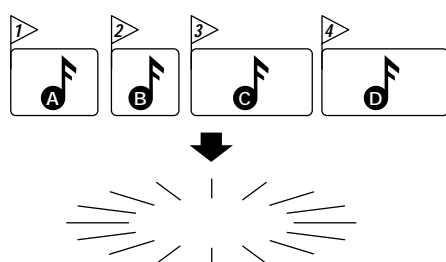
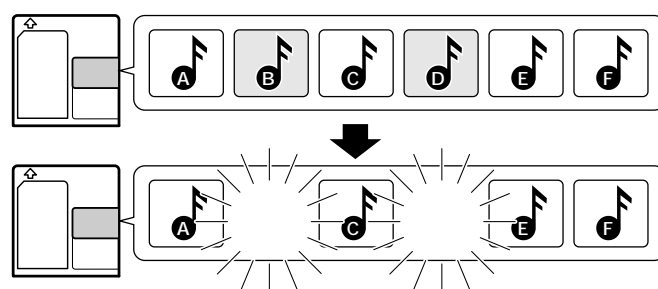
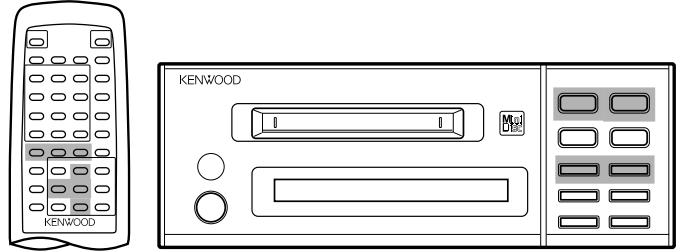

Image of erasing several tracks at a time (QUICK ERASE)



Use the following procedure to erase all of the MD tracks while the player is in stop mode. Be very careful in using this operation because the erased tracks cannot be recovered once the entire Mini Disc has been erased.

Preparation ● Play the title to be erased.



■ : Keys and control used in the operations described on this page.

Erasing a single track during playback (TRACK ERASE)

1 Select "ERASE".

① Press the EDIT key ② Select "ERASE"

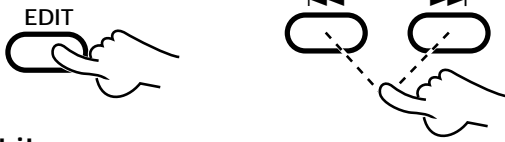

③ Set it.



Each press of the ◀▶ keys switches the operation.

- ① DIVIDE?
- ② COMBINE?
- ③ ERASE?
- ④ MOVE?

- Editing is aborted if no operation has been performed for 8 seconds.

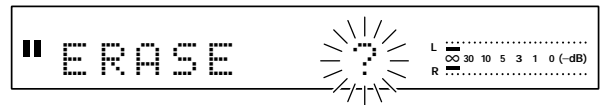

2 Execute the track erasure operation.

① Confirmation of erasing ② Execute the track erasure operation.

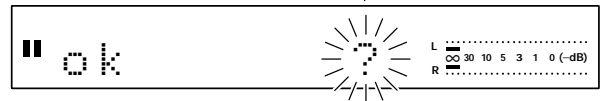
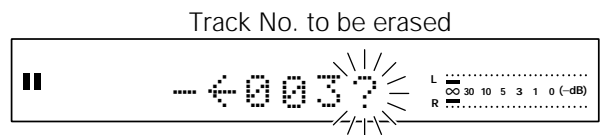

- The track being played is erased (together with its track title).

3 Eject the Mini Disc. (Main unit only)

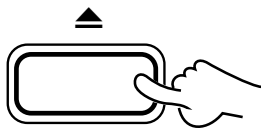

Information is being written.

Mini Disc has been ejected.

Note While "WRITING" is displayed, do not impact or move the unit because information about recording and editing is being written to the Mini Disc.

Image of track erasure

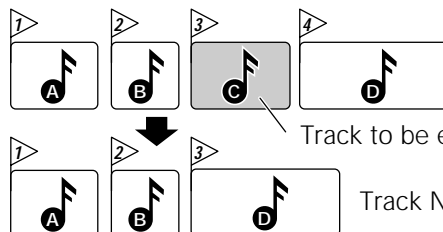

Track to be erased



Track Nos. are adjusted.

The TRACK DIVIDE function can be used to turn the part you want to erase into a track, and that track can be erased with the TRACK ERASE function.



Be careful in using this operation because a track cannot be recovered once it has been erased.

Erasing a part of a track

1 Turn the part to be erased into one track.

 Use the TRACK DIVIDE function and edit the track so that only the part you want to erase becomes a track.  36

2 Erase the part to be erased.

 Use the TRACK ERASE function to erase the "track" (part you want to erase) that you made in step 1.  42

3 Eject the Mini Disc. (Main unit only)

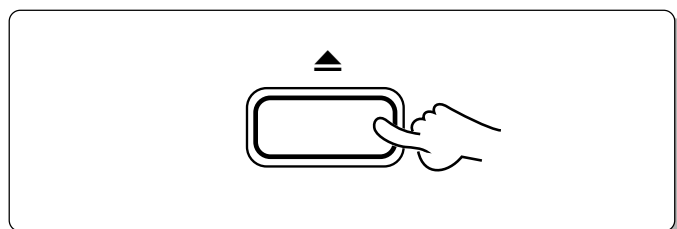

Information is being written.

Mini Disc has been ejected.

 **Note** While "WRITING" is displayed, do not impact or move the unit because information about recording and editing is being written to the Mini Disc.

TRACK DIVIDE 36

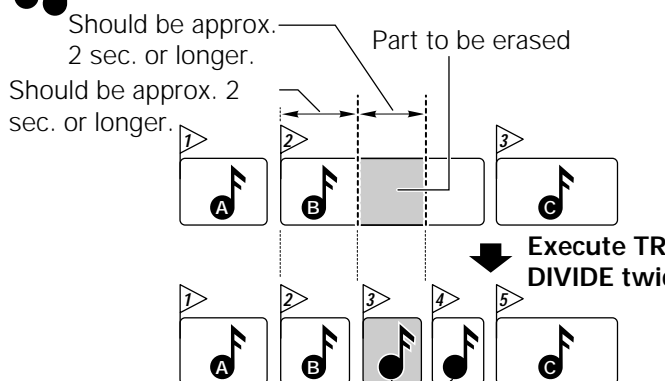

The part divided with TRACK DIVIDE becomes one "track".

TRACK ERASE 42

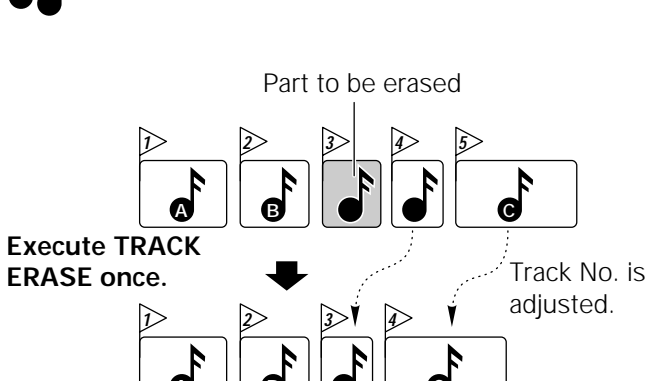

The space left after erasing is filled by subsequent tracks which move along.

When titles are assigned to a disc and its tracks, the titles cannot only be displayed during playback but title search (searching a track by the title) is also made possible. The assigned titles can be changed or deleted with the same procedure.

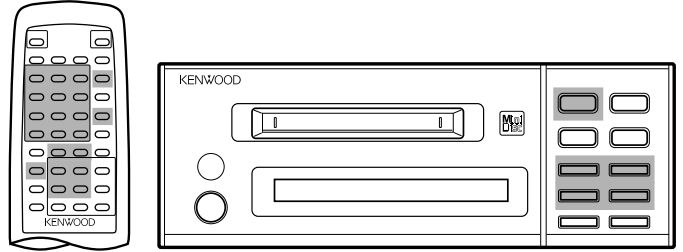

 : Keys and control used in the operations described on this page.

How to edit titles

1 Activate the title input mode.

- ① Press the TITLE INPUT key.

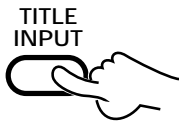

- ② Select the title to be edited.

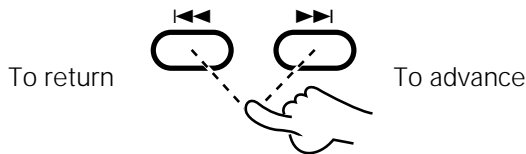

- With repeated operation while ② or ③ is being displayed, the track No. or the preset title (PRE1 to 9) will be selected.

- ③ Set the selection.



To abort operation, press the TITLE INPUT key again.

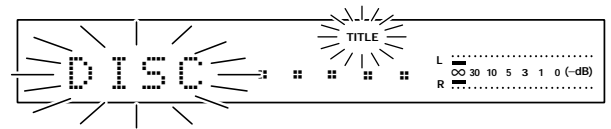

Each press of the   keys switches the operation.

- ① DISC (Disc title)
- ② 001 (Track title)
- ③ PRE1 Pops (Preset title)
- ④ ALL ERASE? (Complete erasure of disc and track titles)
- ⑤ TEXT LOAD

In case of disc title :

Select "DISC".

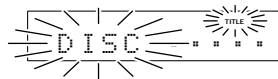

In case of track title :

Select the desired track No.

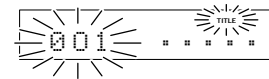

In case of preset title :

Select the desired preset No.



Complete erasure of disc and track titles :



Total number of title characters

Up to 1792 characters can be input per disc and up to 80 characters can be input per track. (In case of alphanumeric and symbol characters) A space (blank character) also required the same amount of data as alphanumeric characters. When deleting a title, it is not recommended to overwrite spaces on previous characters but use the (CLEAR/DELETE) function.

Symbol list (ASCII codes) :

! " # \$ % & ' () * + , - . / : ; < = > ? @ _ ` ^

Preset title list : (Initial setting)

PRE1 Pops → PRE2 Rock → PRE3 Classic →
PRE4 Jazz → PRE5 Disco → PRE6 Best Hits →
PRE7 Air Check → PRE8 No. → PRE9 Vol.

2 Input the title.

1 Select a character group.

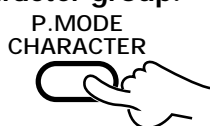

2 Select a character.

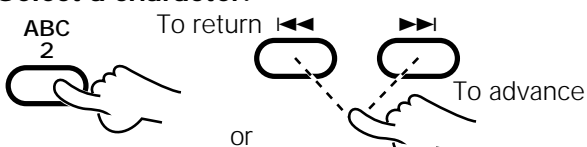

- The character keys can be used for direct selection of characters. When the same key is pressed repeatedly, the characters will change. (Example : When **2** is pressed, the characters will change in the order of **A → B → C.**)

3 Set the selected character.



4 Repeat steps 1 to 3 above.

Each press of the P.MODE/CHARACTER key switches under following the group.

- ① **A~Z**, space (1 blank character)
- ② **a~z**, space
- ③ **0~9**, symbols, preset titles (9 types), and so on.
- The display can be scrolled so that any character (in a single group) can be selected.

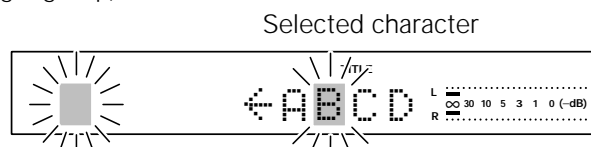

Input place

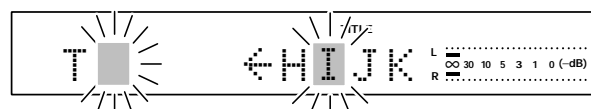

The cursor moves and stands by for the next character input.

- The cursor can be moved to the left and right with the CURSOR/CHECK keys.

3 Execute title assignment.

1 Enter the title in memory.



2 Complete the operation.

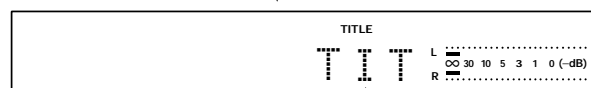
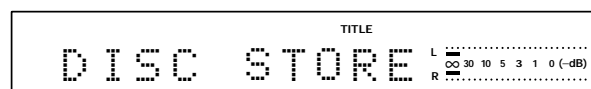
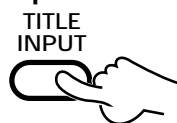

The title is scrolled.

4 Eject the Mini Disc. (Main unit only)

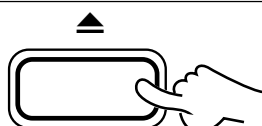

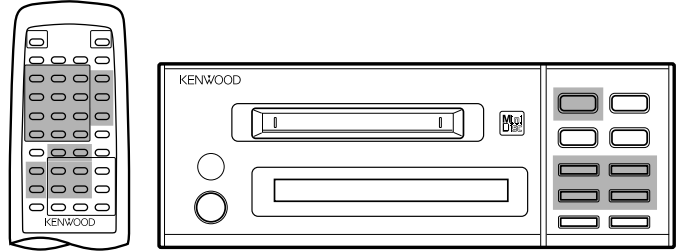

 : Keys and control used in the operations described on this page.

Changing or deleting a title

1 Perform step **1** of "Activate the title input mode."

→  44

2 Change or delete characters one by one.

1 Move the character to the desired character (to be changed).

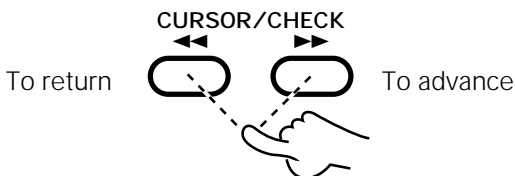

2 Select a character group.



3 Select overwrite or insert mode.



4 Select a character.

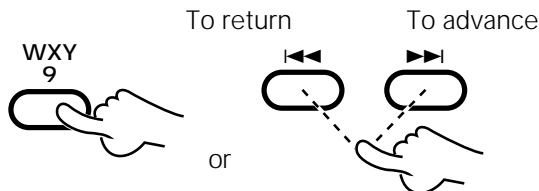

- The character keys can be used for direct selection of characters. When the same key is pressed repeatedly, the characters will change. (Example : When **9** is pressed, the characters will change in the order of **W → X → Y**.)

5 Set the selected character.



Selected character blinks.

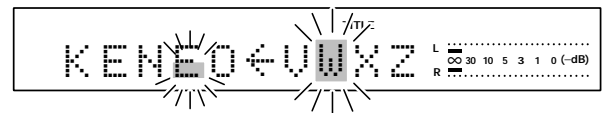

- If the title to be changed is too long to be displayed on the display section, press the **◀** or **▶** key to scroll the display so that the characters hidden until then appear.

Each press of the P.MODE/CHARACTER key switches under following the group.

- A~Z, space (1 blank character)
- a~z, space
- 0~9, symbols, preset titles (9 types), and so on.

Each press of the TITLE SEARCH key switches the operation.

- Overwrite mode : To replace characters
- Insert mode : To insert characters before the cursor

→  47

- The display can be scrolled so that any character (in a single group) can be selected.

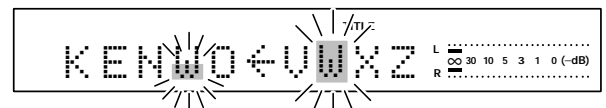

The correct character is selected.

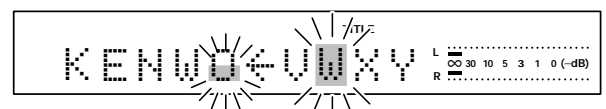

The cursor moves.



It is possible to change all of the characters of a title by repeating steps **1** to **5**. Press the CLEAR/DELETE key to erase the title (delete the characters).

3 Execute title change or deletion.

1 Enter the title in memory.



2 Complete the operation.

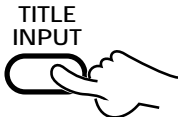

4 Eject the Mini Disc. (Main unit only)

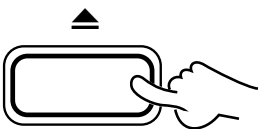
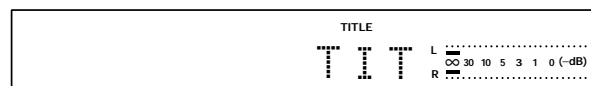
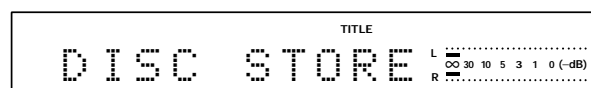
The title is scrolled automatically.



Information is being written.

Mini Disc has been ejected.

Note While "WRITING" is displayed, do not impact or move the unit because information about recording and editing is being written to the Mini Disc.

In regard to preset titles

When a preset title (PRE1 to 9) is used at the time of title character input, input with individual characters is not required and the efficiency is improved. Long titles or frequently used titles can be recorded to any preset title. (To return rewritten preset titles to the initial setting, refer to "Resetting the microcomputer". → 49)

Example : Changing PRE4 (Jazz) to (artist name) and adding a title to track No. 2

Changing (rewriting) a preset title

- | | |
|--|----------------------|
| 1 Press the TITLE INPUT key. | P44 step 1-1 |
| 2 Select "PRE4" (Jazz) with the ◀◀ ▶▶ key and press the SET key. | P44 step 1-2③ |
| 3 Select the character group with the P. MODE/CHARACTER key. | P46 step 2-2 |
| 4 Enter the artist name (first character) with the number keys (or the ◀◀ ▶▶ key) and press the SET key. | P46 step 2-4⑤ |
| 5 Repeat step 4 to enter the artist name (from the second letter on) and press the ENTER key. | |

Preset title input

- | | |
|--|----------------------|
| 1 Press the TITLE INPUT key. | P44 step 1-1 |
| 2 Select track No. 2 with the ◀◀ ▶▶ key and press the SET key. | P44 step 1-2③ |
| 3 Select a preset title (PRE display) in the character group ③ , using the P.MODE/CHARACTER key. | P45 step 2-1③ |
| 4 Select "PRE4" with the ◀◀ ▶▶ key and press the SET key. | P45 step 2-2③ |
| 5 Press the ENTER key and the TITLE INPUT key in this order. | P45 step 3-1② |

Functions of the keys

TITLE SEARCH key :

At the time of title input, switching is possible between overwrite mode and insert mode.

CHECK/SPACE key :

Press to enter (insert) a space (one blank character) immediately before the character in the cursor position and move the characters after it by one character forward. Multiple spaces can also be entered by pressing the key successively (or holding it depressed). The spaces are mainly used to leave spaces for later addition of characters before adding characters to a title.

Cursor types

Overwrite mode : The cursor "■" becomes large,
 Insert mode : The cursor "■" becomes small.

When a disc corresponding to CD-TEXT is inserted into a system-connected CD player, the recorded text information (data) and the tracks can be copied to the MD. This operation is not possible when the CD character information contains a copy prohibition code. → 8

Preparation

- ❶ Select the CD input on the amplifier.
- ❷ Switch off the CD PGM mode.
- ❸ Stop the CD and the MD.
- ❹ Use the **REC INPUT** key of the MD to select the input mode "DIGITAL 1". → 30

To copy the CD text

1 Load the CD text into the MD.

❶ Press the **TITLE INPUT** key.

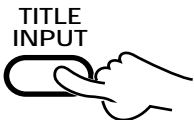

❷ Select "TEXT LOAD".

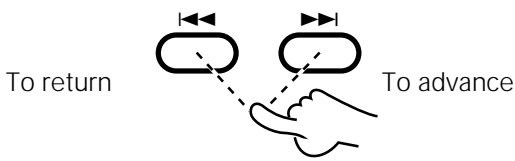

❸ Set it.

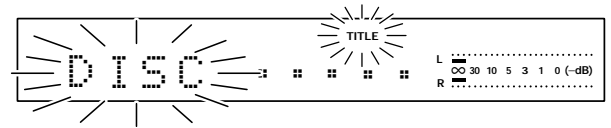

Each press of the **◀▶** keys switches the operation.

- ① DISC
- ② 001
- ③ PRE1 Pops
- ④ ALL ERASE?
- ⑤ TEXT LOAD?



Display after execution

- COMPLETE! : Loading completed.
- CAN'T LOAD : Loading not possible. → 48

2 Record the track while copying the text.

❶ Set the MD to recording pause.



❷ Play the CD.

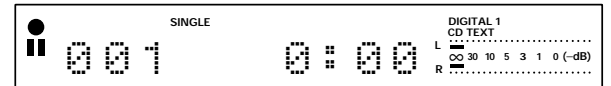

Display after execution

- CAN'T COPY!: Copying is not possible. → 48

3 Eject the Mini Disc. (Main unit only).

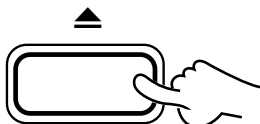

Information is being written. Mini Disc has been ejected.

Note While "WRITING" is displayed, do not impact or move the unit because information about recording and editing is being written to the Mini Disc.

What appears to be a malfunction may not always be serious. If your unit should not perform as expected, consult the table below to see if the problem can be corrected before seeking help from your dealer or service representative.

Operation to reset

The microprocessor may fall into malfunction (impossibility to operate erroneous display, etc.) when the power cord is unplugged while power is ON or due to an external factor. In this case, execute the following procedure to reset the microprocessor and return it to normal condition.









Unplug the power cord from the power outlet then, while holding the eject (▲) key depressed, plug the power cord again.

- Please note that resetting the microprocessor clears the contents stored in, it returns the microprocessor to the condition when it left the factory.

Symptoms related to MD standard

Symptom	Cause
"DISC FULL" is displayed while the disc still has a remaining recordable time.	<ul style="list-style-type: none"> ● More than 255 tracks (track No. 256 or more) cannot be recorded. (There may be also cases in which recording is impossible while the track number is less than 256.) In such a case, the REMAIN time display shows "0:00".
The recordable time does not increase after a short track has been erased.	<ul style="list-style-type: none"> ● The remaining time display becomes "0:00" when the actual total remaining time of the Mini Disc is less than 12 seconds. The recordable time display changes when the total time of the erased track exceeds 12 seconds. ● When a Mini Disc has been subjected to repeated editing, the remaining time may not increase even after a short track has been erased.
Tracks cannot be combined.	<ul style="list-style-type: none"> ● A track created as a result of an editing operation may sometimes be impossible to be combined with another track.
The total of the recorded time and recordable time does not coincide with the total recording time of the MD (60 or 74 min.).	<ul style="list-style-type: none"> ● As recording is performed on a minimum recording basis of 2 seconds, the displayed time may not coincide with the consumed disc capacity.
Sound is interrupted when a track created by editing is subjected to fast forward or fast backward operation.	<ul style="list-style-type: none"> ● Sound interruption may occur due to a combination of various factors, and it is not a malfunction.
Tracks are not numbered correctly.	<ul style="list-style-type: none"> ● A short track may be created depending on the contents of the recorded source (CD, for example).
The period in which "READING" is displayed is abnormally long.	<ul style="list-style-type: none"> ● "READING" is displayed for a longer period than usual when a brand-new recordable Mini Disc (a virgin disc) is loaded.
The displayed time is incorrect when a monaurally-recorded Mini Disc is played.	<ul style="list-style-type: none"> ● This is because the monaural recording and stereo recording use different formats, and not a malfunction.
The total number of characters used in the titles is less than 1792 characters.	<ul style="list-style-type: none"> ● As the title recording areas are used on a per-7-character basis, the total number of input characters may be less than 1792.

Displayed messages and actions to be taken against them

Displayed Message	Meaning	Action
UNLOCK	<ul style="list-style-type: none"> ● An attempt is made to record digital signal from a source using other sampling frequency than 38kHz, 44.1 kHz, 48 kHz. ● The optical fiber cable is unplugged or loose. (The connector is not connected.) 	<ul style="list-style-type: none"> ● Use analog recording. →  24 ● Connect the optical fiber cable correctly. →  12 →  13
SCMS ON	<ul style="list-style-type: none"> ● An attempt is made to record digital signal from a source while its digital copy has been prohibited by SCMS. 	<ul style="list-style-type: none"> ● Use analog recording. →  24
DISC FULL	<ul style="list-style-type: none"> ● There is no recordable area on the disc. ● An attempt is made to record a 256th track. 	<ul style="list-style-type: none"> ● Use another recordable disc. ● More than 255 tracks cannot be recorded per disc.
TITLE FULL	<ul style="list-style-type: none"> ● An attempt is made to assign a title with more characters than usable. 	<ul style="list-style-type: none"> ● Refer to "Total number of title characters". →  44
BLANK DISC	<ul style="list-style-type: none"> ● The disc does not contain any recordings. 	<ul style="list-style-type: none"> ● When playback is required, use a recorded disc.
NO TRACKS	<ul style="list-style-type: none"> ● The disc does not contain any tracks but has a disc title. 	<ul style="list-style-type: none"> ● The disc can be used for recording without any problem.
READING	<ul style="list-style-type: none"> ● The TOC*1 data of the disc is being read. 	<ul style="list-style-type: none"> ● This is a normal operation.
WRITING	<ul style="list-style-type: none"> ● The data related to editing or recording is being written in the disc. 	<ul style="list-style-type: none"> ● This is a normal operation.
DISC ERROR	<ul style="list-style-type: none"> ● The contents of UTOC*2 are abnormal. 	<ul style="list-style-type: none"> ● Perform "QUICK ERASE" to delete all titles "← ALL?". If this is not possible, use another disc. →  40
CAN'T EDIT	<ul style="list-style-type: none"> ● An attempt is made to perform editing beyond the restrictions, for example to erase a track which is too short. 	<ul style="list-style-type: none"> ● Perform editing following the restrictions.
? (blinking)	<ul style="list-style-type: none"> ● This is a message for confirming if editing can really be executed. 	<ul style="list-style-type: none"> ● Press the ENTER key to execute editing.
PROTECTED	<ul style="list-style-type: none"> ● The Mini Disc is in the "WRITE PROTECT" condition. 	<ul style="list-style-type: none"> ● Release the "WRITE PROTECT" condition. →  9
PLAY ONLY	<ul style="list-style-type: none"> ● A playback-only Mini Disc is loaded. 	<ul style="list-style-type: none"> ● Load a recordable Mini Disc. →  10
CAN'T LOAD	<ul style="list-style-type: none"> ● A CD corresponding to CD-TEXT has not been inserted into the CD player. ● The CD player is not connected via an optical fiber cable. 	<ul style="list-style-type: none"> ● Set a CD corresponding to CD-TEXT into the CD player. ● Connect the CD player with an optical fiber cable and match the REC INPUT of the MD recorder.
CAN'T COPY	<ul style="list-style-type: none"> ● Title copying may not be possible, depending on the disc. 	<ul style="list-style-type: none"> ● The titles of this disc can not be copied. (Replace the disc.)

Other symptoms

Symptom	Cause	Remedy
Sound is not output even when the play key is pressed.	<ul style="list-style-type: none"> ● The cords are connected erroneously. ● No disc has been loaded. ● A non-recorded disc has been loaded. 	<ul style="list-style-type: none"> ● Connect the cords in accordance with "System connections". → 12 ● Load a disc. → 17 ● Load a prerecorded disc or playback-only disc.
Recording is not possible	<ul style="list-style-type: none"> ● The disc is write-protected. ● An attempt is made to record digital signal from a source while its digital copy has been prohibited by SCMS. ● The recording level is too low (in case of analog recording). ● A playback-only disc has been loaded. ● The disc does not have a recordable area. ● The REC INPUT key is not set to the actual input source. ● If the amplifier is connected to this unit through a system control cord, the amplifier's input selector is set to the MD input. 	<ul style="list-style-type: none"> ● Change the position of the write protect tab to the write position or use a recordable disc. → 9 → 10 ● Use analog recording. → 24 ● Adjust the recording level again. → 24 ● Use a recordable disc. → 10 ● Use another disc. ● Set it according to the actual input source. → 24 → 26 ● Set the amplifier's input selector to other position than MD.
Sound is distorted.	<ul style="list-style-type: none"> ● The recording level has not been adjusted. ● A disc in which distorted sound has been recorded is played. 	<ul style="list-style-type: none"> ● Read "Adjust the recording level". → 24 ● Use another disc.
Noise is noticeable.	<ul style="list-style-type: none"> ● An external noise is induced. 	<ul style="list-style-type: none"> ● Install the unit at a position apart from an electric appliance or TV set.



TOC*1: All minidisks contain a Table of Contents (TOC) in addition to sound signals. The TOC is similar to the table of contents in a book and contains information, such as track numbers, track length, and character information, that cannot be rewritten. → [50](#)

TOC*2: In addition to the TOC, minidisks also contain a special User's Table of Contents (UTO) that contains track number, track length, and character information, that can be rewritten. → [50](#)

[Format]

System	Minidisc digital audio system
Laser	Semiconductor laser
Recording method	Field modulation overwrite method
Audio compression	ATRAC (Adaptive TRansform Acoustic Coding)
Playing rotation	Approx. 400 rpm ~ 900 rpm (CLV)

[D/A conversion]

D/A conversion	1 Bit
Oversampling	128 fs (5644.8 kHz)

[A/D converter]

A/D conversion method	Sigma-delta method
Sampling frequency	44.1 kHz

[Digital audio performance]

Frequency response (playback mode)	8 Hz ~ 20 kHz, ± 1 dB
Signal to noise ratio (playback mode)	More than 92 dB
Dynamic range (playback mode)	More than 90 dB
Total harmonic distortion (1 kHz, playback mode)	Less than 0.007 %
Channel separation (1 kHz, playback mode)	More than 85 dB
Wow & flutter	Less than unmeasurable limit
Analog input sensitivity / input impedance	300 mV / 70 kΩ
Analog output level / load impedance	1.2 V / 3.2 kΩ
Digital input	
Optical(Wave length 660 nm)	- 15 dBm ~ - 21 dBm

[General]

Power consumption	14 W
Dimensions	W : 200 mm (7 - 7 / 8") H. : 77 mm (3 - 1 / 16") D. : 247 mm (9 - 3 / 4")
Weight (Net)	2.1 kg (4.6 lb)



1. KENWOOD follows a policy of continuous advancements in development. For this reason specifications may be changed without notice.
2. The full performance may not be exhibited in an extremely cold location (under a water-freezing temperature).

For Canada

IC REGULATION

NOTICE : This Class B digital apparatus meets all requirements of the Canadian Interference-Causing Equipment Regulations.



For your records

Record the serial number, found on the back of the unit, in the spaces designated on the warranty card, and in the space provided below. Refer to the model and serial numbers whenever you call upon your dealer for information or service on this product.

Model _____ Serial Number _____